



# **Concrete Finishers**

---

**Health & Safety Manual**

# Table of Contents

## CHAPTER 2: Rights and Responsibilities

- Duties of Workplace Parties ..... 2-1
  - Constructor ..... 2-1
  - Employer ..... 2-1
  - Supervisor ..... 2-2
  - Worker ..... 2-3
- Health and Safety Representatives and JHSCs ..... 2-3
  - Health and Safety Representative..... 2-3
  - Joint Health and Safety Committee (JHSC) ... 2-4
  - Legislative Requirements ..... 2-4
- Worker’s Rights ..... 2-5
- Mandatory Training ..... 2-5
- Jobsite Postings ..... 2-6
- Construction Health and Safety Legislation... 2-6

## CHAPTER 3: Safety Planning and Coordination

- Site Communication and Coordination ..... 3-1
- Health and Safety Policy and Program ..... 3-1
- Safety Talks ..... 3-1
- Log Book..... 3-2
- Job Safety Analysis (JSA)..... 3-2
  - Creating a JSA ..... 3-3
- Due Diligence Checklist ..... 3-4
- Sample JSA..... 3-6
- JSA Form ..... 3-7
- Safety Talk Report Form ..... 3-8

## CHAPTER 4: Emergency Preparedness

- Emergency Response Plan ..... 4-1
- Emergency Response Procedures ..... 4-3
- First Aid..... 4-3
- Fire ..... 4-4
- Fall Rescue Procedures ..... 4-4
- Emergency Response Planning Checklist..... 4-6

## CHAPTER 5: Tool and Equipment Hazards

- Bolt Cutters ..... 5-1

- Bull Float/Highway Straightedge ..... 5-1
- Caulking Dispenser ..... 5-2
- Caulking Gun ..... 5-2
- Communication Devices ..... 5-2
- Compressor..... 5-3
- Concrete Bucket ..... 5-3
- Concrete Buggy ..... 5-4
- Concrete Come-along..... 5-5
- Concrete Conveyor ..... 5-5
- Concrete Pump..... 5-6
- Concrete Pump Line Tug with Placing Boom ... 5-6
- Concrete Truck ..... 5-7
- Concrete Vibrator ..... 5-7
- Copperhead Laser Screed Machine® ..... 5-8
- Crow Bar ..... 5-8
- Diamond Grinder ..... 5-8
- Diamond Polishing Machine ..... 5-9
- Double Float and Trowel Machine..... 5-9
- Dry-Shake Hardeners ..... 5-10
- Electrical Cords ..... 5-11
- Fibre Conveyor ..... 5-12
- Forms ..... 5-12
- Generator..... 5-13
- Hand Floats and Trowels ..... 5-13
- Hand Grinder ..... 5-13
- Hand Sprayer..... 5-14
- Hammer..... 5-14
- Insulated Blanket ..... 5-15
- Ladder..... 5-15
- Laser ..... 5-16
- Laser Screed Machine® ..... 5-16
- Lift Truck ..... 5-17
- Lighting ..... 5-18
- Liquid Applied Sealers, Coatings, Densifiers, and Floor Systems..... 5-18
- Manual Screed..... 5-19
- Mixing Drill..... 5-19
- Mortar Mixer..... 5-19

# Table of Contents

- Power Rake ..... 5-20
- Power Washer ..... 5-20
- Powered Elevating Work Platform..... 5-21
- Quick-cut Saw ..... 5-22
- Scarifier..... 5-23
- Shot Blasting ..... 5-23
- Shovel..... 5-23
- Single Float and Trowel Machine..... 5-24
- Skill Saw ..... 5-25
- Slip Sheet..... 5-26
- Telehandler..... 5-26
- Vapour Retarder..... 5-27
- Vehicles (On-site) ..... 5-27
- Vehicles (Personal) ..... 5-28
- Vibratory Truss Screed ..... 5-28
- Walk-Behind Manual Vibrating Screed..... 5-29
- Walk-Behind Saw ..... 5-29
- Wet Curing Cover ..... 5-30
- Wire Mesh or Rebar ..... 5-30

## CHAPTER 6: Occupational Health

- Workplace Hazardous Materials Information System (WHMIS)..... 6-1
  - Worker Education..... 6-1
  - WHMIS Labels..... 6-1
  - Hazard Classes and Pictograms..... 6-2
  - Safety Data Sheets (SDSs)..... 6-2
- Carbon Monoxide ..... 6-2
  - Health Effects of CO..... 6-3
  - Preventing Exposure to CO ..... 6-3
  - Temporary Heaters..... 6-4
- Isocyanates ..... 6-4
  - Preventing Exposure to Isocyanates..... 6-4
- Silica..... 6-5
  - Preventing Exposure to Silica ..... 6-5
- Heat Stress ..... 6-5
  - Preventing Heat Stress ..... 6-6
- Cold Stress ..... 6-6
  - Preventing Cold Stress ..... 6-6
- Hygiene..... 6-8
  - Preventing Hygiene Hazards ..... 6-8
- Impairment..... 6-8
  - Preventing Impairment Hazards ..... 6-8

- Noise..... 6-9
  - Preventing Exposure to Noise ..... 6-9

## CHAPTER 7: Musculoskeletal Disorders

- MSD Risk Factors..... 7-1
- Preventing MSDs..... 7-2

## CHAPTER 8: Personal Protective Equipment

- Hearing Protection ..... 8-1
  - Choosing Hearing Protection Devices..... 8-1
  - Care and Use ..... 8-1
- Eye Protection ..... 8-2
  - Choosing Eye Protection ..... 8-2
  - Care and Use ..... 8-3
  - Contact Lenses..... 8-3
- Head Protection ..... 8-3
  - Care and Use ..... 8-4
- Foot Protection ..... 8-4
- Skin Protection ..... 8-5
- High-Visibility Clothing..... 8-5
- Respiratory Protection..... 8-6
  - Air-Purifying Respirators ..... 8-6
  - Supplied-Air Respirators..... 8-7
  - Styles of Facepieces..... 8-7
  - Fit Tests and Seal Checks ..... 8-7
  - Respirator Maintenance ..... 8-8
  - Respirator Selection Guide for Common Construction Activities..... 8-9

## CHAPTER 9: Fall Protection

- Fall Protection Systems..... 9-1
  - Travel Restraint..... 9-1
  - Fall Arrest ..... 9-1
- Fall Hazards ..... 9-2
- Guardrails..... 9-2
  - Safe Work Practices..... 9-3
- Floor Openings..... 9-3
  - Safe Work Practices..... 9-3
- Temporary Stairs..... 9-4
  - Temporary Stair Hazards ..... 9-4
  - Safe Work Practices..... 9-5

## APPENDIX A: STRETCHING EXERCISES

## APPENDIX B: HAND SIGNALS

## CHAPTER 2—RIGHTS AND RESPONSIBILITIES

Each workplace party has certain responsibilities that contribute to a safe and healthy workplace. Before beginning work, it is important for everyone to know and understand their rights and responsibilities under Alberta law.

This chapter outlines the various responsibilities and rights and applicable regulations. It also lists the documents that must be posted in an accessible location or available at all jobsites.

### Duties of Workplace Parties

An essential part of health and safety legislation is the importance of having a strong “Internal Responsibility System” (IRS). The basis of this concept is that everyone in the workplace has a direct responsibility for health and safety. Whether you are a worker, a supervisor, or the owner of the company, health and safety is your responsibility.

### Constructor

- 23. (1)** *A constructor shall ensure, on a project undertaken by the constructor that,*
- (a) the measures and procedures prescribed by this Act and the regulations are carried out on the project;*
  - (b) every employer and every worker performing work on the project complies with this Act and the regulations; and*
  - (c) the health and safety of workers on the project is protected.*

### Employer

- 25. (1)** *An employer shall ensure that,*
- (a) the equipment, materials and protective devices as prescribed are provided;*
  - (b) the equipment, materials and protective devices provided by the employer are maintained in good condition;*
  - (c) the measures and procedures prescribed are carried out in the workplace;*
  - (d) the equipment, materials and protective devices provided by the employer are used as prescribed; and*
  - (e) a building, structure, or any part thereof, or any other part of a workplace, whether temporary or permanent, is capable of supporting any loads that may be applied to it,*
    - (i) as determined by the applicable design requirements established under the version of the Building Code that was in force at the time of its construction,*
    - (ii) in accordance with such other requirements as may be prescribed, or*
    - (iii) in accordance with good engineering practice, if subclauses (i) and (ii) do not apply.*
- (2)** *Without limiting the strict duty imposed by subsection (1), an employer shall,*
- (a) provide information, instruction and supervision to a worker to protect the health or safety of the worker;*
  - (b) in a medical emergency for the purpose of diagnosis or treatment, provide, upon request, information in the possession of the employer, including confidential business information, to a legally qualified medical practitioner and to such other persons as may be prescribed;*



- (c) *when appointing a supervisor, appoint a competent person;*
  - (d) *acquaint a worker or a person in authority over a worker with any hazard in the work and in the handling, storage, use, disposal and transport of any article, device, equipment or a biological, chemical or physical agent;*
  - (e) *afford assistance and co-operation to a committee and a health and safety representative in the carrying out by the committee and the health and safety representative of any of their functions;*
  - (f) *only employ in or about a workplace a person over such age as may be prescribed;*
  - (g) *not knowingly permit a person who is under such age as may be prescribed to be in or about a workplace;*
  - (h) *take every precaution reasonable in the circumstances for the protection of a worker;*
  - (i) *post, in the workplace, a copy of this Act and any explanatory material prepared by the Ministry, both in English and the majority language of the workplace, outlining the rights, responsibilities and duties of workers;*
  - (j) *prepare and review at least annually a written occupational health and safety policy and develop and maintain a program to implement that policy;*
  - (k) *post at a conspicuous location in the workplace a copy of the occupational health and safety policy;*
  - (l) *provide to the committee or to a health and safety representative the results of a report respecting occupational health and safety that is in the employer's possession and, if that report is in writing, a copy of the portions of the report that concern occupational health and safety; and*
  - (m) *advise workers of the results of a report referred to in clause (l) and, if the report is in writing, make available to them on request copies of the portions of the report that concern occupational health and safety.*
- 26. (1)** *In addition to the duties imposed by section 25, an employer shall,*
- (a) *establish an occupational health service for workers as prescribed;*
  - (b) *where an occupational health service is established as prescribed, maintain the same according to the standards prescribed;*
- (c) *keep and maintain accurate records of the handling, storage, use and disposal of biological, chemical or physical agents as prescribed;*
  - (d) *accurately keep and maintain and make available to the worker affected such records of the exposure of a worker to biological, chemical or physical agents as may be prescribed;*
  - (e) *notify a Director of the use or introduction into a workplace of such biological, chemical or physical agents as may be prescribed;*
  - (f) *monitor at such time or times or at such interval or intervals the levels of biological, chemical or physical agents in a workplace and keep and post accurate records thereof as prescribed;*
  - (g) *comply with a standard limiting the exposure of a worker to biological, chemical or physical agents as prescribed;*
  - (h) *establish a medical surveillance program for the benefit of workers as prescribed;*
  - (i) *provide for safety-related medical examinations and tests for workers as prescribed;*
  - (j) *where so prescribed, only permit a worker to work or be in a workplace who has undergone such medical examinations, tests or x-rays as prescribed and who is found to be physically fit to do the work in the workplace;*
  - (k) *where so prescribed, provide a worker with written instructions as to the measures and procedures to be taken for the protection of a worker; and*
  - (l) *carry out such training programs for workers, supervisors and committee members as may be prescribed.*
- Supervisor**
- 27. (1)** *A supervisor shall ensure that a worker,*
- (a) *works in the manner and with the protective devices, measures and procedures required by this Act and the regulations; and*
  - (b) *uses or wears the equipment, protective devices or clothing that the worker's employer requires to be used or worn.*
- (2)** *Without limiting the duty imposed by subsection (1), a supervisor shall,*
- (a) *advise a worker of the existence of any potential or actual danger to the health or safety of the worker of which the supervisor is aware;*

- (b) where so prescribed, provide a worker with written instructions as to the measures and procedures to be taken for protection of the worker; and
- (c) take every precaution reasonable in the circumstances for the protection of a worker.

## Worker

**28. (1)** A worker shall:

- (a) work in compliance with the provisions of this Act and the regulations;
- (b) use or wear the equipment, protective devices or clothing that the worker's employer requires to be used or worn;
- (c) report to his or her employer or supervisor the absence of or defect in any equipment or protective device of which the worker is aware and which may endanger himself, herself or another worker; and
- (d) report to his or her employer or supervisor any contravention of this Act or the regulations or the existence of any hazard of which he or she knows.

**(2)** No worker shall:

- (a) remove or make ineffective any protective device required by the regulations or by his or her employer, without providing an adequate temporary protective device and when the need for removing or making ineffective the protective device has ceased, the protective device shall be replaced immediately;
- (b) use or operate any equipment, machine, device or thing or work in a manner that may endanger himself, herself or any other worker; or
- (c) engage in any prank, contest, feat of strength, unnecessary running or rough and boisterous conduct.

In addition to the OHS Act and applicable regulations, there may be jobsite-specific rules that workers must follow.

### Did You Know?

In 2014, the definition of “worker” in section 1(1) of the OHS Act was amended to include unpaid interns, co-op students, and certain other learners and trainees participating in a work placement program. Volunteers are not covered by this new definition.

## Health and Safety Representatives and JHSCs

On some projects, a Health and Safety Representative or a Joint Health and Safety Committee (JHSC) is required to look after the health and safety interests of workers on the jobsite. (See section 8 and 9 of the OHS Act for more information.)

### Health and Safety Representative

- Must be elected by workers at a construction project when there are more than five employees and when the project lasts more than three months. (When there are 20 employees or more, the employer must establish a Joint Health and Safety Committee).
- Inspects the project at least once a month (or part of the project each month, with the whole project covered at least once a year).
- Makes recommendations or reports findings about any hazards to the employer.
- Gets information from the employer about testing of equipment or materials at the project. When a hazard is suspected at the project, it is often necessary to carry out tests to assess the hazard.
- Is present during an investigation of a work refusal.
- Is consulted about testing and is present to ensure test results are valid.
- May inspect the scene of a critical injury or death.
- Reports the findings to a Ministry of Labour Director.

If a Health and Safety Representative is required on your site, you are legally obligated to identify them by name, trade, and employer. IHSA's *Health and Safety Representative Poster* (PO29) can help workers know who their representative is on site (Figure 2-2).



**Figure 2-2: Health and Safety Representative Poster**

## Joint Health and Safety Committee (JHSC)

- Composed of an equal number of worker and employer representatives.
- Identifies actual and potential hazards in the workplace.
- Inspects the workplace at least once a month or, if that is not practical, inspects the workplace at least once a year and at least part of the workplace each month in accordance with a schedule agreed upon by the committee and the employer (constructor).
- Is consulted about and present at the beginning of any health- and safety-related testing in the workplace.
- Makes recommendations to the employer about health and safety in the workplace.
- Participates in the first and second stage investigation of work refusals and inspects workplaces when there are critical injuries or fatalities.

In addition to the principle functions of a JHSC listed above, a number of other powers and responsibilities can be found in section 9 of the OHSA.

If a JHSC is required on your site, you are legally obligated to identify the members by name, trade, and employer. IHSA's *Joint Health and Safety / Worker Trades Committee Poster* (PO41) can help workers know who their committee members are on site. The poster is double-sided, with JHSC members on one side and WTC members on the other side (Figure 2-3).

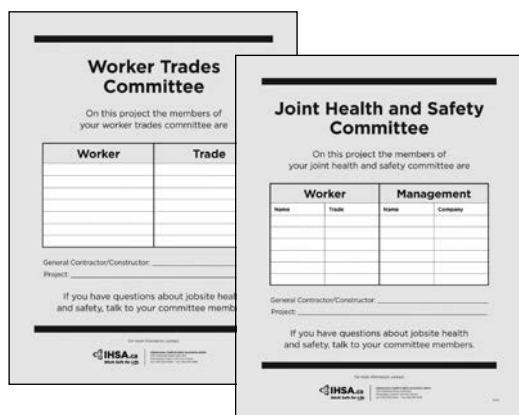

**Figure 2-3: JHSC/WTC Poster**

## Legislative Requirements

The OHSA requires a Health and Safety Representative or JHSC under the following circumstances.

No. of Workers	Legislative Requirement
1 to 5	You are not required to have a JHSC or a Health and Safety Representative unless your workplace uses designated substances.
6 to 19 (project lasting more than 3 months) <b>OR</b> 6 plus (project lasting less than 3 months)	You are required to have one Health and Safety Representative who is selected by the other workers or their union. If your workplace uses designated substances, you are required to have a JHSC.
20 to 49 (project lasting more than 3 months)	You are required to have a JHSC with at least two members—one management representative and one non-management worker.
50 plus (project lasting more than 3 months)	You are required to have a JHSC with at least four members—two management representatives (at least one must be certified) and two non-management workers (at least one must be certified).

**Note:** Certified members of the JHSC receive special training in workplace health and safety, giving them additional powers under the OHSA. Collectively, management-certified and worker-certified members can order the employer or constructor to stop work if they have “reason to believe” that dangerous circumstances exist in the workplace.

On March 1, 2016, a new JHSC Certification Training Standard came into effect. Training providers must be approved by the Chief Prevention Officer (CPO) and their training program must meet the Training Program Standard.

Under the new Program Standard, there are three JHSC Certification Training courses:

1. JHSC Certification Part One (generic)
2. JHSC Certification Part Two (sector-specific)
3. JHSC Certification Refresher

JHSC members trained under the new Standard will be required to take a JHSC Certification Refresher course every three years to maintain their certification. JHSC members certified under the 1996 Standard (prior to February 29, 2016) do not need to retake any certification training under the new Standard, including a Refresher course.

## Worker's Rights

In addition to duties and responsibilities, workers have three basic rights:

1. **The right to know** what hazards are in the workplace (The employer has a duty to give that information to the Health and Safety Representative or JHSC.)
2. **The right to participate** in keeping the workplace healthy and safe by joining a Health and Safety Committee or becoming a Health and Safety Representative.
3. **The right to refuse unsafe work** that the worker believes endangers their health or safety or the health or safety of others. (See OHS, s. 43(3).)

Workers who exercise these rights—or who act in compliance with any other legislation under the OHS or the regulations—are protected against reprisals by their employer. Reprisals include dismissal, discipline, suspension, penalties, intimidation, or coercion. (See OHS, s.50.)

## Mandatory Training

Training gives workers the knowledge to recognize the hazards they face and do their jobs safely. However, many construction workers do not have the training required by law. They may not know they need it and their employers may not know they have a legal duty to provide it.

The Occupational Health and Safety Awareness and Training regulation (297/13) requires every worker and supervisor to complete basic health and safety awareness training. The training must include the following topics:

1. The duties and rights of workers under the OHS
2. The duties of employers and supervisors under the OHS
3. The roles of a Health and Safety Representative and Joint Health and Safety Committees under the OHS
4. The roles of the Ministry, the Workplace Safety and Insurance Board and entities designated under section 22.5 of the OHS with respect to occupational health and safety
5. Common workplace hazards
6. The requirements set out in Regulation 860 (Workplace Hazardous Materials Information System (WHMIS)) with respect to information and instruction on controlled products
7. Occupational illness, including latency.

A free resource is available on the Ministry of Labour's website ([www.labour.gov.on.ca/english/hs/training/](http://www.labour.gov.on.ca/english/hs/training/)) to assist with the instruction of the awareness training (Figure 2-4).

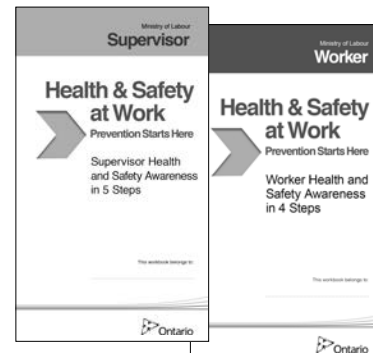

**Figure 2-4: Health and Safety Awareness Training for Workers and Supervisors**

O. Reg. 297/13 also requires members of a JHSC to receive approved Certification Training before they can become certified members (see page 2-4) and any worker who may use a method of fall protection to receive approved Working at Heights training (see Chapter 9).

In addition to this mandatory training, the OHS and Construction Projects regulation assigns many responsibilities to a **competent person** or **competent worker**. By definition, the person or worker must be qualified because of **knowledge, training, and experience** to either organize or perform the work. Therefore, anyone doing work assigned to a competent person or competent worker **MUST** be trained.

## Jobsite Postings

The OHSA, construction regulations, Workplace Safety and Insurance Act (WSIA), and Employment Standards Act (ESA) specify items that must be posted or available at a jobsite.

- OHSA and Regulation for Construction Projects (the “green book”)
- Regulation 1101: First Aid Requirements (under the WSIA)
- Company health and safety policy and program
- MOL inspector’s orders and report
- Emergency response plan
- In Case of Injury* poster issued by the WSIB (P085 available at [ihsa.ca](http://ihsa.ca))
- MOL Form 0175: Notice of Project (if applicable under O. Reg. 213/91, s.6)
- Address and phone number of the nearest MOL office
- DANGER signs in hazardous areas (if applicable)
- Location of toilets and clean-up facilities
- Inspection card for first aid box
- Valid certificate of first-aider on duty
- MOL Form 1000: Registration of Constructors and Employers Engaged in Construction (available)
- Name of constructor and head office info
- Name, trade, and employer of JHSC members or Health and Safety Representative
- MOL’s *Health and Safety at Work: Prevention Starts Here* poster
- Company workplace violence and harassment policy
- (M)SDS of any hazardous physical agents that may be used at the jobsite (available)



**Mandatory Posters**

## Construction Health and Safety Legislation

### Occupational Health and Safety Act

The OHSA sets out the health and safety responsibilities of all parties on a construction project. Responsibilities are prescribed for constructors, employers, supervisors, and workers in particular.

### Relevant Regulations under the OHSA

- **Regulation for Construction Projects (213/91)**  
This regulation provides the legal requirements for such things as ladders, personal protective equipment, fire safety, etc.
- **Critical Injury—Defined (Reg. 834)**
- **Designated Substance—Asbestos on Construction Projects and in Buildings and Repair Operations (Reg 278/05)**
- **Designated Substances (Reg. 490/09)**
- **Control of Exposure to Biological or Chemical Agents (Reg. 833)**
- **Workplace Hazardous Materials Information System (WHMIS) (Reg. 860)**
- **Confined Spaces (Reg. 632/05)**
- **Unilateral Work Stoppage (Reg. 243/95)**
- **Occupational Health and Safety Awareness And Training (Reg. 297/13)**
- **Noise (Reg. 381/15)**

### Workplace Safety and Insurance Act

The WSIA establishes a system to ensure that workers are compensated for work-related injuries and occupational diseases. Participating employers, in return, are given immunity from civil suits for worker injury/disablement.

The WSIA is also concerned with ensuring, wherever possible, the successful return to work of employees following work-related injuries or occupational illnesses.

### Relevant Regulations under the WSIA

- **First Aid Requirements (Reg. 1101)**

# CHAPTER 3—SAFETY PLANNING AND COORDINATION



On many construction projects, workers from different companies may be working at the same time. As a result, the work of one company may affect the health and safety of workers from another company.

The OSHA gives overall authority for health and safety at a construction project to the **constructor**. The constructor is the workplace party who:

- undertakes a project for an owner
- has the greatest control over health and safety at the entire project
- is ultimately responsible for the health and safety of all workers
- must ensure that all the employers and workers on the project comply with the OSHA and its regulations.

## Site Communication and Coordination

Since the constructor is in the best position to coordinate work, they also have the best opportunity to coordinate health and safety.

Planning for health and safety should be done before the project starts and before each new phase. It is important for the constructor to work with individual contractors to anticipate and identify the hazards that will be created and to ensure that necessary precautions are taken and explained to all workers.

Employers and workers must work together to identify hazards and control them. A lack of

effective planning and communication about hazards in the workplace may place workers in danger.

If something does go wrong on a construction site, the employer must prove “due diligence.” This means “reasonable steps that a person takes to satisfy a legal requirement.” The employer must be able to document that every reasonable precaution was taken to keep people safe on the project.

## Health and Safety Policy and Program

Employers and supervisors can use the Due Diligence Checklist at the end of this chapter as a guideline for meeting their safety obligations. It covers the documents that should be maintained, training requirements, disciplinary procedures, and other key requirements.

They can also visit the **Policy and Program Resources section** of [ihsa.ca](http://ihsa.ca) for tools and templates to develop or update their company’s health and safety policy and program

## Safety Talks

Safety talks are a hands-on way to remind workers that health and safety are important on the job. Each safety talk provides specific information on hazards for a particular topic. It also outlines things workers can do to prevent injuries and illness.

They may be given by a supervisor, a Health and Safety Representative, a safety officer, or someone with similar duties. They should take about five minutes and may include a demonstration. They should be given on the jobsite before a shift starts as a reminder of the hazards that workers may encounter that day.



Record the date, time, location, and topic of the safety talks given on the project. They can serve as evidence of due diligence.

IHSA's *Safety Talks Manual* (V005) has over 120 safety talks on a variety of topics (Figure 3-1). For example, there's a talk on "Floor sealing" in the **Techniques and Tools** section. These talks are also available to download from our safety talks web page ([ihsa.ca/resources.aspx](http://ihsa.ca/resources.aspx)).



**Figure 3-1: Safety Talks Manual**

Safety talks are ideal for daily or weekly safety meetings. But on their own, they aren't enough to keep workers safe. A safety talk is not a replacement for health and safety training.

## Log Book

A log book, sometimes called a journal, is an important form of communication on a worksite. Site supervisors should keep a log book as a personal and professional record of daily events on the job.

Maintaining a site log book documents due diligence and offers potential documentary evidence in case of legal disputes. It can tell the story of a project in case you have to answer questions about it later.

When everyone has a different version of past events and people are forgetting what was said or done at crucial times, a good log book may be the best and possibly the only evidence a supervisor can offer. It also provides a suitable location for notes, memos, and follow-up reminders.

IHSA's *Supervisor Log Book* (RF008) contains safety talks, a job safety analysis (JSA) form, a due diligence checklist, inspection checklists, an employee orientation checklist, and other helpful resources to improve communication, planning, and coordination on a job (Figure 3-2).

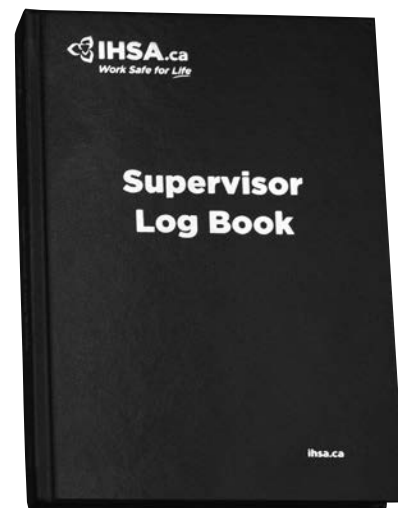

**Figure 3-2: Supervisor Log Book**

## Job Safety Analysis (JSA)

A job safety analysis (JSA), also called a job hazard analysis or job task analysis, is a systematic breakdown of work steps for a specific job in a specific location. It identifies the hazards associated with that job and determines the controls necessary to prevent these hazards.

A JSA may focus on jobs where injuries have been occurring more often, on jobs where there is a greater potential for severe injuries or illness, or on jobs that are new, have been modified, or are not done very often.

By completing a JSA, you ensure that you have planned the work properly and that workers can do it safely. As a written document, it can serve as evidence of due diligence.

JSA's not only help prevent workers from getting injured, but they also help prevent damage to equipment and the environment. By doing so, JSA's help keep work on schedule.

The JSA should be written by a competent person because such a person, as defined by the OSHA, knows what the hazards are on the jobsite. Usually that person is the foreperson or supervisor.

**Creating a JSA**

The procedure for creating a JSA is as follows:

- 1. Write down the job steps** — Each step is necessary to complete the work. Keep them in sequential order. Get the crew and the Health and Safety Representative to help with this part.

The steps should not only be specific to the job, but also specific to the work area. If the work area changes, the steps may need to change as well.

- 2. Identify the hazards associated with each step** — Think about what could go wrong from a health and safety perspective. How would people, equipment, materials, processes, and the surrounding environment contribute to a hazard?

To help you identify potential hazards:

- Ask workers who are familiar with the job.
- Review causes of past injuries or illnesses.
- Consider other work going on near the work area.
- Understand the legislation or regulatory requirements associated with the work.
- Review the manufacturer's instructions for the equipment you are using.
- Consider your own personal experience with the job.

- 3. Determine controls for each hazard** — Each hazard that you identified needs a control. The control explains how you will eliminate the hazard or how you will significantly reduce the risk of injury or illness.

<b>Eliminate the Hazard</b>	<ul style="list-style-type: none"> <li>• Modify the process or choose a safer process.</li> <li>• Improve the work environment (e.g., ventilation).</li> <li>• Modify or change equipment or tools.</li> </ul>
<b>Contain the Hazard</b>	<ul style="list-style-type: none"> <li>• Install barriers, such as guardrails or machine guards.</li> <li>• Enclose the hazard so workers aren't exposed to it.</li> <li>• Install a booth for workers.</li> </ul>
<b>Revise the Work Procedure</b>	<ul style="list-style-type: none"> <li>• Modify the part of the procedure that is hazardous.</li> <li>• Change the sequence of steps.</li> <li>• Add additional steps (such as locking out energy sources).</li> </ul>
<b>Reduce the Exposure</b>	<ul style="list-style-type: none"> <li>• Reduce the number of times workers will encounter the hazard.</li> <li>• Reduce the number of workers exposed to the hazard.</li> <li>• Use personal protective equipment.</li> <li>• Rotate jobs to reduce the length of time each worker is exposed to the hazard.</li> </ul>

- 4. Communicate the JSA to workers** — The JSA won't be effective if workers don't know about them or don't understand them. Review the relevant JSA's before starting work to sure everyone knows how they are supposed to do the job safely.

Use the blank JSA form and sample JSA on pages 3-6 and 3-7 for reference.



## Due Diligence Checklist

**Workplace:**

### 1. Does the employer keep the following types of records or documents?

<input type="checkbox"/> Worker orientation records	<input type="checkbox"/> Records of worker/supervisor training showing the date, names of attendees, and topics covered (e.g., WHMIS)
<input type="checkbox"/> Inspection reports and records of corrective actions taken to solve problems	<input type="checkbox"/> Incident/accident investigation reports and records of corrective actions taken to solve problems
<input type="checkbox"/> Records of meetings and crew talks where safety issues were discussed	<input type="checkbox"/> Supervisor's notes and logs of safety contacts with workers
<input type="checkbox"/> Records showing use of progressive discipline to enforce safety rules and written safe work procedures	<input type="checkbox"/> JHSC meeting reports showing steps taken to address health and safety issues
<input type="checkbox"/> Subcontractor pre-qualification documents	<input type="checkbox"/> Vehicle and equipment log books and maintenance records
<input type="checkbox"/> First aid records, medical certificates, hearing tests	<input type="checkbox"/> Forms and checklists showing that the employer requires workers to follow safe work procedures (e.g., confined space entry permits)
<input type="checkbox"/> Sampling and monitoring records of exposures to harmful substances	<input type="checkbox"/> Emergency response plan and record of drills and any resulting improvements
<input type="checkbox"/> Budget items and purchase orders related to occupational health and safety (OH&S)	<input type="checkbox"/> Statistics on the frequency and severity of accidents
<input type="checkbox"/> Driver abstracts (updated annually) and qualifications	<input type="checkbox"/> For commercial vehicles, records such as bills of lading, manifests, dangerous goods documents, time records, drivers' daily logs and weigh slips

### 2. Do the employer's records or documents show an effective OH&S program?

Do records/documents indicate that the employer/management:		
1. States and communicates a clear workplace OH&S policy	<input type="checkbox"/> Yes	<input type="checkbox"/> No
2. Assigns responsibility and resources for implementing OH&S program to identified person(s)	<input type="checkbox"/> Yes	<input type="checkbox"/> No
3. Includes workplace OH&S issues on management meeting agendas	<input type="checkbox"/> Yes	<input type="checkbox"/> No
4. Requires contractors to conform to OH&S regulations	<input type="checkbox"/> Yes	<input type="checkbox"/> No
5. Ensures records are maintained (See Part 1)	<input type="checkbox"/> Yes	<input type="checkbox"/> No
6. Reviews statistics on the frequency and severity of incidents, as well as injury and illness trends over time	<input type="checkbox"/> Yes	<input type="checkbox"/> No
7. Assigns responsibility for identifying hazards and conducting risk assessments	<input type="checkbox"/> Yes	<input type="checkbox"/> No
8. Implements appropriate controls (engineering, work practice/administrative, PPE) for identified hazards (machine guarding, lockout, confined space, falls from height, chemical and biological hazards, repetitive strain injury, motor vehicle incidents, etc.)	<input type="checkbox"/> Yes	<input type="checkbox"/> No

9. Implements a preventative maintenance schedule as required by manufacturers' and industry recommendations and standards	<input type="checkbox"/> Yes	<input type="checkbox"/> No
10. Addresses Joint Health & Safety Committee or health & safety representative recommendations	<input type="checkbox"/> Yes	<input type="checkbox"/> No
11. Reviews OH&S program activities (e.g., once a year) and makes improvements as needed	<input type="checkbox"/> Yes	<input type="checkbox"/> No
<b>Do records/documents indicate that supervisors:</b>		
12. Receive training to carry out their safety and health responsibilities	<input type="checkbox"/> Yes	<input type="checkbox"/> No
13. Give crew talks/conduct safety meetings	<input type="checkbox"/> Yes	<input type="checkbox"/> No
14. Participate in inspections	<input type="checkbox"/> Yes	<input type="checkbox"/> No
15. Conduct incident/accident investigations	<input type="checkbox"/> Yes	<input type="checkbox"/> No
16. Take action to correct reported hazards	<input type="checkbox"/> Yes	<input type="checkbox"/> No
17. Conduct orientations	<input type="checkbox"/> Yes	<input type="checkbox"/> No
18. Conduct on-the-job training	<input type="checkbox"/> Yes	<input type="checkbox"/> No
19. Evaluate training to ensure that it is effective	<input type="checkbox"/> Yes	<input type="checkbox"/> No
20. Monitor work conditions and practices to ensure compliance with legislation and company policies	<input type="checkbox"/> Yes	<input type="checkbox"/> No
21. Correct employees who are not following rules and procedures	<input type="checkbox"/> Yes	<input type="checkbox"/> No
22. Keep records of progressive discipline	<input type="checkbox"/> Yes	<input type="checkbox"/> No
23. Have OH&S considered as an element in their performance evaluation	<input type="checkbox"/> Yes	<input type="checkbox"/> No
24. Give instructions for using safety equipment (e.g., fire extinguishers, flags, flares)	<input type="checkbox"/> Yes	<input type="checkbox"/> No
<b>Do records/documents indicate that workers:</b>		
25. Receive orientation	<input type="checkbox"/> Yes	<input type="checkbox"/> No
26. Receive specific job instruction	<input type="checkbox"/> Yes	<input type="checkbox"/> No
27. Receive health and safety training (e.g., responsibilities, hazards, engineering controls, written safe work procedures, use of PPE)	<input type="checkbox"/> Yes	<input type="checkbox"/> No
28. Demonstrate the skills/knowledge necessary to perform their jobs safely	<input type="checkbox"/> Yes	<input type="checkbox"/> No
29. Report injuries and hazards	<input type="checkbox"/> Yes	<input type="checkbox"/> No
30. Participate in inspections	<input type="checkbox"/> Yes	<input type="checkbox"/> No
31. Participate in incident/accident investigations	<input type="checkbox"/> Yes	<input type="checkbox"/> No
32. Are qualified for the type of work they do and the vehicles that they operate	<input type="checkbox"/> Yes	<input type="checkbox"/> No

**When dealing with disciplinary procedures for workers, supervisors, and managers who don't follow safety rules or safe work procedures:**

31. Are there disciplinary procedures in place?	<input type="checkbox"/> Yes	<input type="checkbox"/> No
32. Are workers/supervisors/managers aware of them?	<input type="checkbox"/> Yes	<input type="checkbox"/> No
33. Are disciplinary procedures used effectively?	<input type="checkbox"/> Yes	<input type="checkbox"/> No
34. Are they monitored by the Joint Health & Safety Committee or Health and Safety Representative?	<input type="checkbox"/> Yes	<input type="checkbox"/> No
35. Are good records kept of progressive discipline used to enforce safety rules and written safe work procedures?	<input type="checkbox"/> Yes	<input type="checkbox"/> No

## Sample JSA

### Setting up an Extension Ladder

Job Steps	Hazards	Barriers or Controls
<b>Lifting ladder off truck from braces</b>	Strain and sprain	Use mechanical leverage to raise ladder from truck bracket, or mount in an easily accessible location.
		Lift one end at a time.
		Get assistance.
		Carry ladder with feet toward the front so it's ready to set up.
<b>Carrying and setting up ladder</b>	Strain and sprain	Lift ladder onto shoulder directly from truck bracket.
		Ensure good grip before walking.
		Get assistance from second worker for large ladders.
		Bend knees if setting ladder on ground.
		Set ladder feet on ground and walk towards wall raising ladder against wall. Practice this step with small ladders.
	Fall	Adjust ladder footing as required and, where applicable, secure bracing/ stabilizers in place
		Ensure ladder is not leaning, and is on firm footing, and secured from movement.
	Slip and trip	Ensure your path of travel is clear before removing ladder from truck bracket.
		Know where obstacles are before travelling with ladder.
		Make sure you have a clear set-down area.
	Electrocution	Check for overhead wires before setting up ladder.
	<b>Next steps...Climbing, etc.</b>	

JSA No. \_\_\_\_\_

## Job Safety Analysis Form

My Company Name \_\_\_\_\_ Project \_\_\_\_\_

General Contractor \_\_\_\_\_ Supervisor in Charge \_\_\_\_\_

Work Location \_\_\_\_\_ Estimated Start Date/Duration \_\_\_\_\_

Work Description \_\_\_\_\_

Trade Groups (including sub-contractors) \_\_\_\_\_

Major Equipment \_\_\_\_\_

Reference Material \_\_\_\_\_

Job Steps	Hazards	Barriers or Controls

Prepared By \_\_\_\_\_

Approved By \_\_\_\_\_ Date Approved \_\_\_\_\_

**Instructions:**

1. To be prepared by the supervisor most directly involved in the work.
2. Must be approved by preparer’s management supervisor.
3. Must be reviewed by all workers involved in the work.
4. Emergency plan must be considered.
5. If the work plan changes and the JSA is amended, changes must be reviewed by all workers involved in the work.

**Safety Talk Report Form**

Title of Safety Talk \_\_\_\_\_

Company	Project
Talk given by	Date

Crew attending

List other topics discussed during the talk

Concerns

Response/follow-up

Signed \_\_\_\_\_ Title \_\_\_\_\_

Use this master to make copies. Fill out a report form for each talk delivered.  
Retain a copy for company records.

## CHAPTER 4—EMERGENCY PREPAREDNESS



An emergency is an unplanned event that has the potential to harm the life, health, or safety of a person, or to damage the environment or public property.

The following are some of the emergencies that may occur in concrete finishing operations:

- a worker falling from heights
- a worker who becomes unconscious
- a worker being struck by equipment
- cuts or other injuries with substantial loss of blood
- broken bones
- extreme weather such as tornados, floods, etc.
- a fire.

However, your worksite may have particular hazards that could result in a emergency not listed here.

### Emergency Response Plan

Every construction project needs an emergency response plan before work begins so that everyone is prepared in case of an emergency. Since the size and complexity of a project differs from site to site, the planning necessary for emergencies will also differ.

An effective emergency response plan must include the following:

#### A. Assessment/Hazard Identification

Identify hazards and assess potential risk by answering these questions:

- What can go wrong?
- What are the consequences?

#### B. Emergency Resources

Determine what resources are available for the hazards identified and assessed. Verify that 911 operates in the area. If not, make alternative arrangements.

Maintain on-site resources such as fire extinguishers, spills containment equipment, and first aid kits. Outside help may be so far away that on-site resources are necessary, such as fire protection or ambulance and medical resources in remote areas.

#### C. Communication Systems

To relay accurate information quickly, reliable communications equipment must be used, procedures developed, and personnel trained. A backup system is a good idea in case the emergency destroys phone lines, for instance.

The type and location of emergency communication systems must be posted on the project. Emergency instructions and phone numbers must be prominently posted near all telephone locations.

These should include the phone numbers for:

- Fire Department
- Police
- Ambulance
- Nearest Hospital
- Company Official

The site address or location should also be included. *The Emergency Response Poster* (P103), available from IHSA, can be used to record this and other information (Figure 4-1).

**EMERGENCY RESPONSE**  
Have a Plan

**FIRE** **POLICE** **AMBULANCE**

LOCAL EMERGENCY NUMBER

**SITE LOCATION**

Name of Superintendent  
Phone  
Address  
Name of First Aid Person  
Gas  
Hydro  
Water  
Telecommunication  
Poison Control 1-800-268-9017  
Ministry of Labour  
Ministry of the Environment 1-800-268-0960  
Nearest Hospital  
Other

**HOSPITAL**  
(insert map of nearest hospital location.)

IHSA.ca 1-800-263-5024  
Work Safe For Life

**Figure 4-1: Emergency Response Poster**

## D. Administration of the Plan

The person in charge of administering and organizing the plan must ensure that

- Everyone clearly understands their roles and responsibilities in the plan
- Adequate emergency resources are available for each stage of the project
- The plan is reviewed regularly and always after an emergency to correct any shortcomings.

## E. Emergency Response Procedure

The Emergency Response Procedures chart (Figure 4-2) outlines standard emergency response procedures. STOP and ASSESS the situation before performing any of the tasks. Stay calm to provide an example to others.

Emergency Procedures	
<b>1</b>	<p><b>STAY CALM</b> DO NOT PANIC. Your behaviour can influence others so staying calm will help the emergency response.</p>
<b>2</b>	<p><b>TAKE COMMAND</b> Call—or delegate someone to call—emergency services (911) immediately and explain the situation. Assign someone to meet and direct the ambulance to the location.</p>
<b>3</b>	<p><b>ASSESS THE SITUATION</b> Use extreme caution when approaching the scene to avoid being injured yourself. Try to determine what happened and what the emergency is. Try to eliminate or control the cause of the emergency to prevent further danger to the injured worker, to others, or to the property. Give first aid as soon as possible.</p>
<b>4</b>	<p><b>PROVIDE PROTECTION</b> Safeguard the area to protect others from being injured and prevent further losses. You may be called upon to help divert traffic, suppress a fire, prevent objects from falling, or shut down equipment or utilities.</p>
<b>5</b>	<p><b>PRESERVE THE SCENE</b> Do not disturb anything except to save a life, relieve suffering, or prevent immediate or further losses. Barricade, rope off, or post a guard at the scene to make sure that nothing is moved until the authorities have completed their investigation.</p>
<b>6</b>	<p><b>FOLLOW PROCEDURES</b> Follow the procedures outlined in your company's emergency response plan. Ensure that senior management is informed. They can contact the proper authorities, notify relatives, and begin the procedures for reporting and investigating the incident.</p>

**Figure 4-2: Emergency Procedures**

## F. Communication of the Procedure

- Review the procedure with subcontractors, workers, and suppliers to ensure that it covers their activities.
- Review it with owner/client in operating plants to ensure that hazards are identified and covered.
- Review it regularly with the JHSC or Health and Safety Representative to address new hazards or significant changes in site conditions.
- Post the procedure in a conspicuous location.

When developing your plan, make sure it always reflects current conditions on the jobsite.

For more detailed information on developing emergency response plans, refer to the *Emergency Response Planning* booklet (B030) available from IHSA and the Emergency Response Planning Checklist at the end of this chapter.

## Emergency Response Procedures

Before you begin work on a jobsite, make sure you are familiar with the emergency response procedures for that site (Figure 4-2).

The site supervisor should be able to provide information about

- Emergency warning alarms and codes
- Emergency telephone numbers
- Nearest hospital
- Rescue procedures
- Meeting or muster points
- Names of persons capable of administering first aid
- Location of emergency equipment such as fire extinguishers

## First Aid

All workplaces covered by the *Workplace Safety and Insurance Act* are required to have a first aid station and trained first aid personnel on site. The specific requirements in Regulation 1101: First Aid Requirements covers such things as

- Requirements of a first aid station
- Minimum contents of a first aid box and first aid room
- Items to be displayed on the notice board (WSIB's *In Case of Injury at Work* poster, valid first aid certificates of trained workers on duty, and inspection card for the first aid box)
- Requirements for records of first aid treatments given
- Inspection requirements for first aid boxes, stations, equipment and records.

The first aid station must be easily accessible and must be in the charge of a worker who is certified to give first aid and who works near the first aid box (Figure 4-3). That person must have received training from a recognized provider, such as the St. John's Ambulance or the Canadian Red Cross. For a full list of approved first aid training providers, consult the WSIB's website.



Figure 4-3: First Aid Box and Eye Wash Station



Learning first aid, CPR, and how to use an AED can help you save a life. Knowing how to recognize the signs of someone who is in distress from a heart attack, stroke, or choking, for example, can help you get them the treatment they need quickly. In those cases where every second counts, prompt treatment can mean the difference between loss of life, life-long impairment, or a full recovery.

If you suspect someone is having a heart attack, look for the four Ps:

1. **Pain** – a continuous pain in the chest that may spread to the jaw, neck, or arms.
2. **Pale** skin
3. **Pulse** is rapid and weak
4. **Perspiration**

The signs and symptoms of a stroke vary depending on what part of the brain has been affected. Usually the symptoms show up on one side of the body.

If you suspect a stroke, think **FAST**:

- F – Facial droop.** Ask the person to smile and watch the corners of their mouth.
- A – Arm Drift.** Have the person hold out both arms in front of them and see if one arm drifts back down or can't move at all.
- S – Speech.** Check if the person slurs their words, says the wrong words, or is able to speak at all.
- T – Time.** Get medical help immediately. The earlier a stroke is treated, the better the chance of survival and recovery.

## Fire

Good housekeeping is essential for the prevention of fires. However, if a fire does break out in the workplace, it is important to know what kind of fire extinguisher to use and how to use it.

Section 52 of the Regulation for Construction Projects (213/91) requires that every worker who may need to use fire extinguishing equipment be trained in its use. The regulation also outlines specific locations and circumstances where fire extinguishers must be provided.

Fire extinguishers must always be visible, marked, and easily accessible. They must also be well-maintained, inspected regularly, and refilled or replaced immediately after use.

Every fire extinguisher on a construction project must have an Underwriters' Laboratories of Canada 4A40BC rating. This type of extinguisher can be used on Class A, B, and C fires, the types of fires commonly encountered in construction (Figure 4-4).

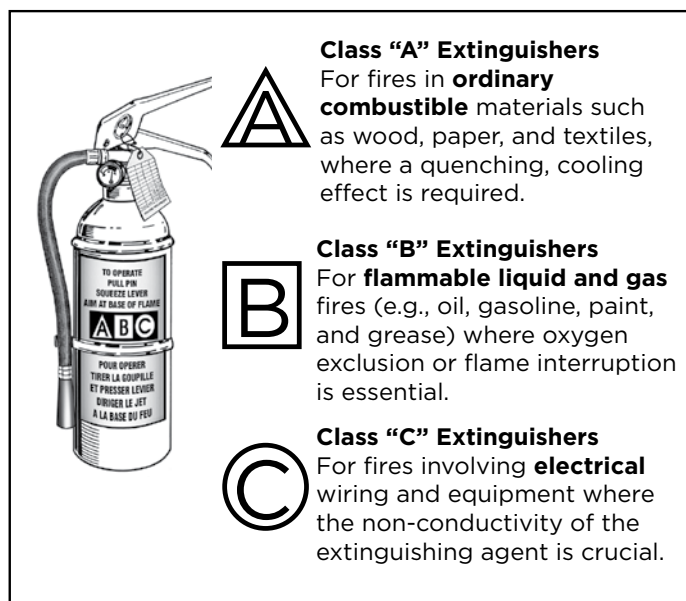

Figure 4-4: Classes of Fire Extinguishers

## Fall Rescue Procedures

If a worker is involved in a fall that has been arrested, it's important to get them to a safe place as quickly as possible without causing further injury or putting the rescuers at risk.

Some of the reasons why a suspended worker should be rescued quickly are listed below

- The worker may have been injured during the fall and may need medical attention.
- The worker may panic if they are left hanging for a long time.
- The event that led to the fall may have created additional dangers that need to be dealt with right away.
- The worker may develop suspension trauma if they are hanging in a safety harness for too long. Suspension trauma causes the blood to pool in the lower body, depriving the brain of oxygen.

Section 26.1(4) of the Regulation for Construction Projects (213/91) requires that before workers use any fall arrest system or safety net on a project, the employer must develop written rescue procedures.

In many cases, the rescue plan can be simple. A ladder or elevated work platform can be used to reach suspended workers and get them down safely. In other cases, it may make more sense to haul them back up to the level from which they fell or pull the worker in through a nearby window or other opening.

For some projects, the rescue procedures are more complicated. You may need specially trained and equipped personnel from the local fire department. Aerial ladder trucks or other high-reach equipment may be necessary. In extreme cases, the fire department may use rappelling techniques to reach trapped workers and lift or lower them to a safe level. Always check with the local fire department before a project begins to confirm that the kind of emergency services that may be needed will be available.

Create a rescue plan that is specific to your jobsite and that covers the different types of fall-related rescues that may be necessary. The plan should cover the on-site equipment that you will use, the personnel who will use it, and the procedures for different types of rescue.

Once the written rescue plan has been developed, make sure everyone on the site is familiar with it. That's especially important for any worker who will be using fall protection equipment.

## Emergency Response Planning Checklist

Company:	Date:
Completed by:	Site:

	In Progress	Date Completed
Program Administration (Who is responsible for implementing the plan?)	<input type="checkbox"/>	
Develop an Emergency Response Standard.	<input type="checkbox"/>	
Develop a Site Emergency Plan.	<input type="checkbox"/>	
<ul style="list-style-type: none"> <li>Identify emergency access routes.</li> </ul>	<input type="checkbox"/>	
<ul style="list-style-type: none"> <li>Indicate location of first aid stations/boxes and fire extinguishers.</li> </ul>	<input type="checkbox"/>	
<ul style="list-style-type: none"> <li>Indicate job office(s) and storage facilities (storage for blankets and special rescue equipment).</li> </ul>	<input type="checkbox"/>	
<ul style="list-style-type: none"> <li>Ensure specialized PPE equipment is on site. (Indicate location.)</li> </ul>	<input type="checkbox"/>	
<ul style="list-style-type: none"> <li>Ensure sufficient medical aid supplies are available on site (splints, stretchers, etc.) and indicate location.</li> </ul>	<input type="checkbox"/>	
<ul style="list-style-type: none"> <li>Locate other firefighting equipment (standpipes, Siamese connections, and hydrants).</li> </ul>	<input type="checkbox"/>	
<ul style="list-style-type: none"> <li>Locate main power supply to the project.</li> </ul>	<input type="checkbox"/>	
<ul style="list-style-type: none"> <li>Identify the location of emergency phones. (Post emergency list.)</li> </ul>	<input type="checkbox"/>	
<ul style="list-style-type: none"> <li>Identify nearest hospital or medical centre.</li> </ul>	<input type="checkbox"/>	
<ul style="list-style-type: none"> <li>Identify worker evacuation route(s) and assembly area(s).</li> </ul>	<input type="checkbox"/>	
<ul style="list-style-type: none"> <li>Contact local fire, police, and ambulance and provide them with your site plan and list of potential emergencies.</li> </ul>	<input type="checkbox"/>	
<ul style="list-style-type: none"> <li>Locate services to the project (both above ground and underground).</li> </ul>	<input type="checkbox"/>	
<ul style="list-style-type: none"> <li>Develop on-site traffic routes.</li> </ul>	<input type="checkbox"/>	
<ul style="list-style-type: none"> <li>Locate outside materials storage and fabricating areas.</li> </ul>	<input type="checkbox"/>	

	In Progress	Date Completed
• Locate cranes man/material hoists and unloading docks.	<input type="checkbox"/>	
• Locate flammable/combustible materials and cylinder storage.	<input type="checkbox"/>	
• Locate garbage dumpsters and recycling bins.	<input type="checkbox"/>	
• Complete Hazard Identification and Risk Assessment Form*	<input type="checkbox"/>	
• Determine if “high-level” rescue is a possibility.	<input type="checkbox"/>	
• Develop Emergency Response procedures for items identified in your hazard assessment.	<input type="checkbox"/>	
• Ensure that all trades on site keep daily personnel lists. (In the event of a major emergency, check names against personnel gathered in the assembly area.)	<input type="checkbox"/>	
• Include requirements for written notices. (What’s required? When? Completed by whom? Who does it go to?) See legal obligations.	<input type="checkbox"/>	
• Identify the emergency response (ER) team and alternates. (Post names.)	<input type="checkbox"/>	
• Provide specialized training for ER team members.	<input type="checkbox"/>	
• Designate a contact person to call necessary emergency services and MOL, MOEE, etc.	<input type="checkbox"/>	
• Select member of ER team to meet and direct emergency services vehicles to incident scene.	<input type="checkbox"/>	
• Select team member to deal with media, MOL, MOEE, etc.	<input type="checkbox"/>	
• Ensure all required rescue equipment/materials are readily available on site.	<input type="checkbox"/>	
• Provide for emergency traffic control person (properly trained).	<input type="checkbox"/>	
• Make provisions for cordoning off the accident scene to protect workers.	<input type="checkbox"/>	
• Ensure someone on the ER team documents where the injured worker has been taken (hospital, medical centre, etc.).	<input type="checkbox"/>	
• Set out method of communicating the plan.	<input type="checkbox"/>	

\*Form can be downloaded from: [ihsa.ca/resources/hazard\\_assessment\\_analysis\\_control.aspx](http://ihsa.ca/resources/hazard_assessment_analysis_control.aspx)



# CHAPTER 5—TOOL AND EQUIPMENT HAZARDS

This chapter covers some of the tools and equipment common to the concrete finishing trade, the hazards associated with them, and the preventive measures to control these hazards.

## BOLT CUTTERS



Used to cut wire mesh

### Hazards

- Cuts from sharp teeth of cutter
- Wire mesh springing upwards when cut
- Muscle strain
- Overexertion and repetitive motion of the wrists, arms, and shoulders
- Eye injuries

### Controls

- Adjust the tension. A properly adjusted blade reduces unnecessary overexertion and lowers the risk of cutting yourself from using too much force.
- Lubricate the tool to make sure all parts move smoothly.
- **Wear personal protective equipment (PPE).**
  - Safety glasses
  - Work gloves

## BULL FLOAT



Used to consolidate surface voids and make a smooth surface for final finishing

### Hazards

- Muscle or back strain from pushing or pulling concrete
- Awkward positions from bending over and reaching
- Falls from working at heights on elevated slabs
- Electrical contact from the handle of the bull float or highway straightedge if they come into contact with nearby energized power sources
- Being struck by the bull float or straightedge
- Striking other equipment nearby with the bull float or straightedge

### Controls

- Always look to make sure that no workers or equipment will be hit by or hit the handle of the bull float or highway straightedge.
- Stretch regularly.
- Rotate the job among members of the crew.
- When using a bull float, keep one foot in front of the other. This position is less awkward than when the feet are closer together. It requires less bending of the back and improves balance.
- When working at heights, always make sure guardrails are in place.
- Be aware of your surroundings and nearby electrical sources.

## HIGHWAY STRAIGHTEDGE



Used to improve flatness of surface

*Image courtesy of William Conway/Progress Photography*

**Note:** Before using any tool, be sure to read the manufacturer's instructions. They take precedence over the information provided above.

## CAULKING DISPENSER (MANUAL, PNEUMATIC, GAS, OR ELECTRIC)



Used to dispense joint sealants and joint filling compounds

### Hazards

- Exposure to vapours from caulking material
- Skin irritation or allergic reaction from coming in contact with caulking
- Carbon monoxide from engine exhaust

### Controls

- Do not let caulking material touch your skin.
- Before use, read the Safety Data Sheet (SDS) to understand the health hazards and precautions to follow for caulking materials.
- Ensure adequate ventilation.
- **Wear PPE.**
  - Gloves
  - Respiratory protection (as specified by the SDS for the caulking compound)
  - Safety glasses or goggles

## CAULKING GUN



Used to fill joints in the floor

### Hazards

- Exposure to toxic vapours
- Awkward positions from bending over to fill the joints

### Controls

- Consult the SDS for any hazardous materials you are working with.
- Sit on a stool and roll yourself along the joint when filling.
- Rotate between caulking and other tasks during the day.
- Stretch regularly.
- Rotate the job among members of the crew.
- Change position (i.e., sit or kneel using kneepads) when working at or near ground level.

## COMMUNICATION DEVICES



### Hazards

- Distractions from smartphones, tablets, and music players
- Distractions causing workers to be struck by moving vehicles and equipment
- Distractions causing slips, trips, and falls

### Controls

- Do not talk, text, email, surf, or play games while working, operating equipment, or driving.
- Focus on the safe performance of your work at all times.
- Use communication devices only on your break or in designated safe-work areas, if possible.
- Turn off your mobile device when working. The ringer may startle you or someone else in the area.
- Never operate your mobile device near flammable fumes or liquid, or in a flammable environment.
- Follow the company's policy on cell phone use. If the company does not have a policy, encourage them to develop one.

**Note:** Before using any tool, be sure to read the manufacturer's instructions. They take precedence over the information provided above.

**COMPRESSOR**



Used to power impact tools and other equipment powered by compressed air

**Hazards**

- Carbon monoxide exposure from gasoline-powered engines
- Exposure to high-pressure air
- Attached hoses whipping through the work area and striking nearby workers
- Noise exposure

**Controls**

- Conduct a pre-operation inspection. (Refer to operator’s manual.)
- Keep hoses as short as possible to minimize whipping action.
- Do not use compressed air to clean off your clothes or skin.
- Place compressor as far away from workers as possible to minimize exposure to noise.
- Never leave compressor unattended while power is on.
- Make sure all connections to tools are secure.
- **Wear PPE.**
  - Safety glasses or goggles
  - Hearing protection

**CONCRETE BUCKET**



Used to carry fresh concrete from the concrete truck to the point of deposit

**Hazards**

- Hoisting and swinging hazards
- Being struck by bucket
- Being struck by material when opening bucket
- Burns or skin sensitization from wet cement coming in contact with exposed skin
- Electrical shock from contact with overhead powerlines

**Controls**

- Do not put yourself in between a fixed structure and the bucket.
- Protect other workers from swinging hazards.
- Never stand under a bucket that is being hoisted.
- Maintain good body positioning. A wide stance with secure footing minimizes stress on your back.
- If you are not involved in the pouring, keep away from where the bucket lands.
- Beware of contact with overhead powerlines. No part of a vehicle or its load shall encroach on the minimum distances to powerlines as outlined in the table below (O. Reg. 213/91, s.188).

Voltage Rating	Minimum Distance
750 to 150,000 volts	3 metres (10 feet)
150,000 to 250,000 volts	4.5 metres (15 feet)
More than 250,000 volts	6 metres (20 feet)

- **Wear PPE.**
  - Gloves
  - Safety glasses or goggles

**Note:** Before using any tool, be sure to read the manufacturer’s instructions. They take precedence over the information provided above.



## CONCRETE BUGGY



**Used to transport fresh concrete from the concrete truck to the point of deposit**

### Hazards

- Carbon monoxide exposure from engine exhaust
- Being struck by moving buggy
- Being struck by bucket
- Being struck by material when opening bucket
- Burns or skin sensitization from wet cement coming in contact with exposed skin
- Buggy tipping or flipping over on inclines
- Being struck by reversing vehicles

### Controls

- Conduct a pre-operation inspection. (Refer to operator's manual.)
- When mounting or dismounting from the buggy:
  - Make sure it is stopped and the parking brake is on
  - Use three-point contact and face the buggy
- Do not operate a buggy on very steep slopes.
- Do not speed. Operate at walking speed around other workers.
- Do not overload the buggy. Refer to the operator's manual for the rated load capacity.
- Inspect the driving surface and avoid:
  - Holes
  - Obstacles
  - Weak spots on floor
  - Oil spills and wet spots
  - Anything else that might cause loss of control
- Carry free-flowing and loose materials only. Do not transport large or chunky material that could cause the buggy to tip and throw the operator off.
- Ensure adequate ventilation.
- Avoid sudden stops, starts, or changes in direction.
- When working around concrete buggies, never place yourself between a fixed structure and the buggy.
- If operator does not have a clear view, use a signaller.
- **Wear PPE.**
  - Retroreflective vest
  - Gloves that protect skin from contact with wet cement (waterproof)
  - Clothing that covers exposed skin
  - Hearing protection

**CONCRETE COME-ALONG**

Used to push or pull concrete into place and level it off in preparation for screeding

**Hazards**

- Overexertion from pushing and pulling heavy concrete
- Awkward postures from bending over slightly to push and pull heavy concrete
- Repetitive motion injuries

**Controls**

- Keep your back as straight as possible to prevent lower back injuries when working with the come-along.
- Limit the amount of concrete that is pushed or pulled with the come-along.
- Stretch regularly.
- Rotate the job among members of the crew.
- When pulling a come-along, keep one foot in front of the other. This position is less awkward than when the feet are closer together. It requires less bending of the back and improves balance.

**CONCRETE CONVEYOR**

Used to carry fresh concrete from the concrete truck to a concrete buggy or the point of deposit

**Hazards**

- Carbon monoxide from engine exhaust
- Getting tangled in conveyors, rollers, or other moving parts
- Getting fingers and other body parts caught in the conveyor
- Being struck by moving vehicles

**Controls**

- Make sure that ventilation is adequate.
- Make sure all moving parts have a protective guard in place.
- Keep work area clean and organized.
- Do not wear loose-fitting clothing near moving parts.
- Check that the “Emergency Stop” switch works properly.
- Have a signaller direct all vehicular traffic.
- Do not stand behind conveyor when trucks are backing up.
- Be sure the operator can see you at all times.
- **Wear PPE.**
  - Safety glasses
  - Hearing protection
  - Retroreflective vest

**Note:** Before using any tool, be sure to read the manufacturer’s instructions. They take precedence over the information provided above.

## CONCRETE PUMP



Used to carry fresh concrete from the concrete truck to the point of deposit

### Hazards

- Being struck by boom
- Being struck or thrown by momentum of pump hose
- Being struck by moving concrete truck
- Being struck by particulates from the end of the boom during boom cleaning
- Carbon monoxide from engine exhaust
- Slips and falls
- Burns or skin sensitization from wet cement coming in contact with exposed skin
- MSDs from lifting, carrying, pushing, or pulling concrete hoses
- Falling backwards while pulling hose and pipe
- Hose clamps opening if they're not fastened properly with locking pins
- Pump blockage causing extreme pressure buildup in the hose

### Controls

- Stretch regularly.
- Do not let the boom touch an overhead energized electrical conductor. No part of a vehicle or its load shall encroach on the minimum distances to powerlines as outlined in the table below (O. Reg. 213/91, s.188).

Voltage Rating	Minimum Distance
750 to 150,000 volts	3 metres (10 feet)
150,000 to 250,000 volts	4.5 metres (15 feet)
More than 250,000 volts	6 metres (20 feet)

- Be aware of your surroundings and other workers before moving the pump boom.
- Designate a signaller to start and stop the pump in coordination with the pump operator and other workers.
- Maintain a good body position. A wide stance with secure footing minimizes stress on your back.
- Keep the safety grate over the pump hopper closed while in operation.
- Make sure that the pump stabilizer spreaders have a secure base.
- Ensure workers understand the signs of a blockage in the concrete pump pipeline and which measures to take to prevent blockages from occurring.
- Stay away from the end of the hose discharge area when a blockage is suspected.
- Follow the manufacturer's instructions for the safe operation and maintenance of concrete pumps.

## CONCRETE PUMP LINE TUG WITH PLACING BOOM (REMOTE-CONTROLLED)



Used to move the concrete pump line mechanically

### Hazards

- Carbon monoxide exposure from engine exhaust
- Struck-by injuries from moving equipment

### Controls

- Use only in well-ventilated areas.
- Stand clear of equipment while it's in motion.
- Ensure remote operator has full view of the equipment and workers.

**Note:** Before using any tool, be sure to read the manufacturer's instructions. They take precedence over the information provided above.

**CONCRETE TRUCK**

Used to carry fresh concrete from the batch plant to the jobsite

**Hazards**

- Being struck by the concrete truck or another moving vehicle
- Carbon monoxide from engine exhaust
- Danger of truck tipping near excavations
- Crushing injuries while unfolding concrete discharge chute

**Controls**

- Use a signaller when trucks are backing up.
- If walking around a vehicle, always make eye contact with the driver. Be aware of your surroundings.
- Ensure adequate ventilation.
- Keep the number of concrete trucks in the work area to a minimum.
- Make sure chute is locked when not in use to prevent it from moving unexpectedly.
- **Wear PPE.**
  - Retroreflective vest
  - Safety glasses
  - Gloves

**CONCRETE VIBRATOR**

Used to consolidate concrete around reinforcing steel and to remove air pockets

**Hazards**

- Vibration white finger disease from vibration of the tool
- Hand-arm vibration syndrome (HAVS)
- Electrical shock from damaged electrical cords
- Fire from gasoline-powered backpack vibrators
- Burns or skin sensitization from wet cement coming in contact with skin or eyes
- Splashing concrete into a worker's face while they're performing hand floating tasks low to the ground

**Controls**

- Rotate between vibrating tasks and other tasks during the day.
- Inspect all cords for damage before use.
- Do not smoke while operating a backpack vibrator.
- Wash wet cement off skin immediately with cold, running water.
- Rinse cement out of eyes immediately with cold, running water for at least 15 minutes. Get medical attention if necessary.
- Ensure that workers nearby are protected from being splattered by wet concrete.
- Use the concrete vibrator only in areas that are clear of other workers.
- **Wear PPE.**
  - Safety glasses or goggles
  - Long-sleeved shirt and long pants that covers exposed skin
  - Waterproof rubber boots or overboots
  - Waterproof gloves

**Note:** Before using any tool, be sure to read the manufacturer's instructions. They take precedence over the information provided above.

## COPPERHEAD LASER SCREED MACHINE®



Used to level concrete to a predetermined height

### Hazards

- Carbon monoxide from engine exhaust
- Being struck by moving equipment
- Noise exposure

### Controls

- Conduct a pre-operation inspection. (Refer to operator's manual.)
- Use in a well-ventilated space.
- **Wear PPE.**
  - Safety glasses or goggles
  - Hearing protection

## CROW BAR

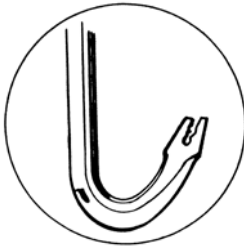

Used to strip formwork and bulkheads

### Hazards

Bruises or eye injuries from using a hammer to wedge a crow bar into a bulkhead

### Controls

- Use a pry bar instead of a crow bar if you need to wedge out a bulkhead.
- **Wear PPE.**
  - Safety glasses

## DIAMOND GRINDER



Used to smooth bumps and imperfections in hardened concrete

### Hazards

- Exposure to carbon monoxide in fumes from gasoline-powered engines
- Cuts from moving parts of tool
- Dust from grinding action
- Flying particles if using the wrong grinding disc

### Controls

- Be sure ventilation is adequate.
- Get assistance and use care when loading and unloading heavy equipment.
- **Wear PPE.**
  - Respiratory protection
  - Hearing protection
  - Safety glasses or goggles

**Note:** Before using any tool, be sure to read the manufacturer's instructions. They take precedence over the information provided above.

### DIAMOND POLISHING MACHINE



Used to put a shine on hardened concrete surfaces

#### Hazards

- Electrical contact from machine
- Carbon monoxide exposure from engine exhaust
- Noise exposure
- Overexertion from handling machine

#### Controls

- Before doing any maintenance, make sure that the equipment is turned off and disconnected from the power source.
- Do not operate on steep incline.
- Use HEPA-filtered equipment.
- Use caution when loading or unloading. Get assistance.
- **Wear PPE.**
  - Safety glasses or goggles
  - Hearing protection
  - Respiratory protection

### DOUBLE FLOAT AND TROWEL MACHINE (OVER-LAPPING AND NON-OVERLAPPING CONFIGURATIONS)



Used to consolidate and finish the slab surface

#### Hazards

- Noise exposure
- Carbon monoxide exposure from engine exhaust
- Cuts from sharp trowel edge or float shoes
- Flammable gasoline
- Falls when working on elevated slabs
- Falls when climbing machine
- Overexertion from lifting or loading machine
- Being struck by machine falling off truck bed
- Being caught or tangled in blades

#### Controls

- Conduct a pre-operation inspection. (Refer to operator's manual.)
- Never operate equipment with protective covers or guards removed.
- Ensure guardrails are in place and secured.
- Check that the "Emergency Stop" button works properly. Never disable it.
- Never leave the trowel unattended while it is running.
- Never fill the fuel tank while the engine is running. Beware of hot engine parts.
- Do not smoke when filling or operating the engine.
- Never leave tools and other equipment on the trowel while it is running.
- Do not wear loose clothing or jewelry.
- Do not operate machine close to other workers.
- Handle metal edges with care.
- Never drive in reverse towards the slab edge or a large slab opening.
- Reduce speed as the machine approaches the slab edge or large opening in slab.
- Approach a slab edge at approximately a 45-degree angle.
- Observe a no-ride zone on elevated slabs. Do not operate within the equipment width of any slab edge or opening. (Use a walk-behind machine instead).
- Beware of protruding rebar or formwork, or other fixed protrusions that can catch and cause the machine to kick back.
- Use a mechanical lifting aid such as a boom truck to load and unload the machine. If loading or unloading by hand, get assistance and use caution.
- Ensure adequate ventilation.
- **Wear PPE.**
  - Hearing protection

**Note:** Before using any tool, be sure to read the manufacturer's instructions. They take precedence over the information provided above.

## DRY-SHAKE HARDENERS

Manual/Hand Application



Gas-powered Application



**Used to harden concrete surfaces**

### Hazards

- Exposure to silica and dust
- Noise exposure
- Pinch points
- Overexertion from lifting or shoveling
- Being struck by moving vehicle
- Carbon monoxide exposure from engine exhaust

### Controls

- Follow the precautions outlined in the SDS for the product you will be using.
- Do not wear loose clothing around equipment and tie hair back.
- Stretch before work begins to minimize overexertion.
- Never lift and twist. Always turn your body with your feet in the direction of travel.
- **Wear PPE.**
  - Safety glasses or goggles
  - Retroreflective vest
  - Respiratory protection
  - Gloves

**Note:** Before using any tool, be sure to read the manufacturer's instructions. They take precedence over the information provided above.

**ELECTRICAL CORDS**

**Used as extension cords or cords attached to portable tools**

**Hazards**

Electrical shock or electrocution in the following circumstances:

- Lack of grounding or double insulation
- Faulty tool cords and extension cords
- Failure to use ground fault circuit interrupters (GFCIs) with tools operated outdoors or in wet or damp locations indoors

**Controls**

- Inspect tool cords and extension cords daily for damage. Look for kinks, cuts, cracks, broken insulation, or makeshift repairs.
- Unless a tool is double insulated (non-conductive), the casing must be grounded and it must have a polarized plug connection.
- Extension cords must be of the outdoor type, be rated for 300 volts, and have an insulated grounding conductor.
- Do not use defective cords. They should either be destroyed or tagged and removed from the jobsite until they are repaired.
- Protect extension cords during use to prevent damage. Never use them to lift, lower, or carry materials or tools.
- Plug extension cords into Class A GFCIs. When built-in GFCI receptacles are not available, plug an in-line GFCI directly into the supply receptacle.
- Electric tools used outdoors or in wet locations must be protected by a Class A GFCI.
- Don't disconnect the tool by yanking or jerking on the cord. You will damage the cord, loosen connections, and run the risk of shock and short-circuit.
- Protect cords from traffic. Run them through a conduit or between planks along either side. If necessary, run them overhead above work or travel areas.
- If any cord feels more than warm to the touch, check circuit for overloading.
- Report any shocks from tools or cords to your supervisor. Tag the tool and don't use it.

**Note:** Before using any tool, be sure to read the manufacturer's instructions. They take precedence over the information provided above.



## FIBRE CONVEYOR



Used to install fibre reinforcing from the ground to the top of a concrete truck

### Hazards

- Getting tangled in moving parts of conveyor or truck drum
- Getting fingers and other body parts caught in conveyor
- Being hit by concrete truck backing up
- Untidy work area (loose bags, wood)
- Eye injuries from fibres that may be ejected when conveyor is in operation

### Controls

- Make sure all moving parts have protective guards in place.
- Never climb the ladder on a concrete truck.
- Keep the work area clean and organized.
- Do not wear loose-fitting clothing near moving parts.
- Check that the “Emergency Stop” switch works properly.
- Have a signaller direct all vehicular traffic.
- Do not stand behind conveyor or a truck when it’s backing up.
- Do not burn fibre cardboard containers on the site.
- **Wear PPE.**
  - Safety glasses or goggles
  - Hearing protection
  - Gloves

## FORMS (BULKHEADS OR CONSTRUCTION JOINTS)



*Image courtesy of Geoff Kinney*

Used to define the size and perimeters of concrete placement

### Hazards

- Being struck by bulkhead or nails
- Tripping over string line or bulkhead
- MSD from excessive weight of form

### Controls

- Use two people to lift forms.
- Make sure you have a clear path of travel.
- **Wear PPE.**
  - Head protection
  - Safety glasses

**GENERATOR**

Used to power electrical equipment when no other power sources are available

**Hazards**

- Carbon monoxide exposure from gasoline-powered engine
- Noise exposure
- Electrical shock
- Fires from improper refuelling

**Controls**

- Conduct a pre-operation inspection. (Refer to operator's manual.)
- Make sure a fire extinguisher is readily available.
- Make sure any equipment/tools plugged into the generator are grounded (i.e., has a 3-pronged plug).
- Inspect cords to ensure they are not damaged, cut, or abraded.
- Do not overload a generator. This can lead to overheating and cause a fire.
- Use ground fault circuit interrupters (GFCIs), especially near wet or damp areas.
- Shut down the generator before refuelling.
- Provide ventilation by putting generator outside.
- Place generator away from workers to minimize carbon monoxide and noise exposure.

**HAND FLOATS AND TROWELS**

Used to consolidate and finish the concrete by hand

**Hazards**

- Cuts from the sharp edges of a trowel
- Awkward positions from working on the hands and knees
- Pressure on the knees from kneeling
- Burns or skin allergy from wet cement coming in contact with exposed skin, especially on the hands and knees

**Controls**

- Rotate the job among members of the crew.
- Stretch regularly.
- Use powered trowels where possible to reduce trowelling by hand.
- Rotate between hand trowelling and other tasks during the day.
- Change positions (i.e., sit or kneel using kneepads) when working at or near ground level.
- **Wear PPE.**
  - Gloves that protect skin from contact with wet cement (waterproof)

**HAND GRINDER**

Used to clean up concrete splatter or to grind concrete and epoxy

**Hazards**

- Cuts from moving parts of tool
- Dust from grinding action
- Flying particles if using the wrong grinding disc
- Grinding stones shattering if they don't match the grinder speed

**Controls**

- Inspect the tool before each use.
- Match the grinding stone to the grinder speed (revolutions per minute).
- Work in well-ventilated areas.
- **Wear PPE.**
  - Respiratory protection
  - Safety glasses or goggles

**Note:** Before using any tool, be sure to read the manufacturer's instructions. They take precedence over the information provided above.

## HAND SPRAYER



Used to apply form oil, sealers, and evaporation reducers

### Hazards

- Vapours from materials being sprayed
- Fluids from sprayer nozzle may be flammable
- Liquids being sprayed may be carried by wind to other workers or objects
- Skin contact with pressurized sealer while opening some types of hand sprayers

### Controls

- Do not smoke near combustible liquids under pressure in a hand sprayer.
- Be aware of the wind direction and workers in surrounding areas. Avoid spraying if those conditions are not favourable.
- Consult the Safety Data Sheet for the material being sprayed to determine the hazards associated with it and control information.
- Always release sprayer pressure before opening and refilling.
- **Wear PPE.**
  - Gloves
  - Respiratory protection
  - Safety glasses or goggles

## HAMMER

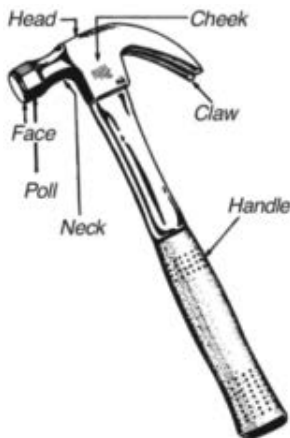

Used to build formwork, strip forms, and clean and remove nails from lumber

### Hazards

- Striking fingers, face, or other parts of the body
- Overexertion and repetitive motion of the wrists, arms, and shoulders
- Flying particles or nails causing eye injuries
- Hand-arm vibration syndrome (HAVS)

### Controls

- Use hammers with shock-absorbing material on the handle to reduce vibration.
- Use a hammer with a hand grip suited to the size of your hand to minimize discomfort.
- Clean the face of the hammer with sandpaper to remove glue or other debris that may cause the hammer to slip.
- **Wear PPE.**
  - Safety glasses

**INSULATED BLANKET**

Used to protect the slab surface and retain heat in cold weather

**Hazards**

The wind picking up the blanket and striking or pushing nearby workers

**Controls**

Use caution in windy conditions. Keep the blanket low to the ground when installing or removing.

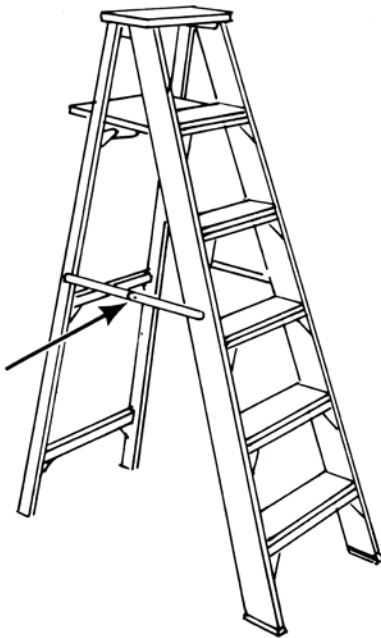
**LADDER**

Used to access and egress elevated slabs

**Hazards**

Falling from the ladder (Note: This is one of the most common causes of workplace injuries and death.)

**Controls**

- Do NOT work from a ladder. Instead, install permanent stairs or use a stair scaffold.
- If working from a ladder is the safest way to perform the task, conduct a hazard assessment to make sure any hazards are identified and controlled.
- If a ladder is used for access or egress, it must be used in accordance with the manufacturer's instructions.
- Inspect ladders before each use. Any damaged ladder must be taken out of service immediately.
- Maintain three-point contact while climbing up or down. Do not carry any tools, equipment, or materials while climbing a ladder.
- Never lean over the sides of a ladder. Keep your centre of gravity (centre of body at belt height) between the side rails of the ladder.

**Note:** Before using any tool, be sure to read the manufacturer's instructions. They take precedence over the information provided above.

## LASER



Used to check elevations of granular bases and to set formwork bulkheads to finished floor elevation

### Hazards

Laser burns causing damage to eyes:

- Retina damage: Symptoms include headaches and the sudden appearance of floaters (swirling distortions) in your vision. Serious eye injuries from a laser can lead to permanent blindness.
- Cornea damage: Minor burns to the transparent layer of tissue covering the eye can cause a gritty feeling, like sand in the eye.

### Controls

- Know the class of laser you are working with.
  - Class 1 and Class 2 lasers are low powered and won't damage the eye under normal operating conditions
  - Class 3R lasers are intermediate in power and can cause eye damage if looked at directly
  - Class 3B and Class 4 lasers are higher in power and can cause eye damage, skin damage, and fires
- Post warning signs and barrier tape to warn other workers that a laser is in use.
- Set the laser above or below eye level.
- **Wear PPE.**
  - Safety glasses or other appropriate eyewear as required by the class of laser

## LASER SCREED MACHINE®



Used to level concrete to a predetermined height

### Hazards

- Getting fingers and other parts of body pinched between machine parts
- Being struck or entangled by the screed head, boom, or other moving parts
- Carbon monoxide exposure from engine exhaust
- Falling off machinery

### Controls

- Conduct a pre-operation inspection. (Refer to operator's manual.)
- Be sure operator has clear view of the direction of travel before moving.
- Ensure adequate ventilation.
- Make sure a fire extinguisher is readily available.
- Use three-point contact to climb the screed and face the ladder.
- **Wear PPE.**
  - Hearing protection
  - Appropriate eyewear as required by the class of laser

**LIFT TRUCK**

**Used to transport and hoist equipment and materials around a jobsite**

**Hazards**

- Being hit by moving lift truck
- Carbon monoxide exposure from engine exhaust
- Pinch points
- Lift truck tipping over because the surface (ground, temporary access covers, etc.) is uneven, sloping, or uncompacted

**Controls**

- Operator must possess a certificate of training.
- No part of a load must pass over any worker
- A lift truck left unattended must be immobilized and secured against accidental movement
- Forks, buckets or other attachments must be in the lowered position or firmly supported
- Do not exceed the maximum rated load. Follow the vehicle's height and weight restrictions on the load chart
- When a load is in the raised position, an operator must be at the controls
- If an operator does not have a clear view, use a signaller who has been instructed in hand signals for managing traffic in the workplace
- Carry load as close to the ground or floor as possible.
- Secure all loads from tipping over
- When a lift truck operator has to enter or exit a vehicle, it must be immobilized and secured against accidental movement.
- A lift truck must not be used to support, raise, or lower a worker
- Barriers, warning signs, designated walkways, or other safeguards must be provided in areas where pedestrians are exposed to the risk of collision
- Drive slowly (at walking speed) around workers
- **Wear PPE.**
  - Retroreflective vest around moving equipment

**Note:** Before using any tool, be sure to read the manufacturer's instructions. They take precedence over the information provided above.

## LIGHTING



Used to illuminate dark areas

### Hazards

- Slipping or tripping over debris and other objects
- Falling through openings or down stairs

### Controls

- Ensure the areas you work in (including access/egress stairs and passageways) are adequately lit and tidy.
- Clean up the jobsite and remove rubbish daily.
- Keep materials piled, stacked, or stored neatly away from well-trafficked areas.
- Ensure floor or stair openings are securely covered and well-marked.

## LIQUID APPLIED SEALERS, COATINGS, DENSIFIERS, AND FLOOR SYSTEMS



Used for curing, sealing, or cleaning concrete

### Hazards

#### CURING MEMBRANES

- Flammable liquids and vapours
- Inhalation may cause eye, nose, and throat irritation
- May cause health effects such as cancer

#### SILICATE DENSIFIERS

- Flammable liquids and vapours
- Serious eye irritation
- May cause health effects such as genetic defects and cancer

#### EPOXY URETHANE FLOOR SYSTEMS

- Flammable liquids and vapors
- Eye irritation

### Controls

#### CURING MEMBRANES

- Keep away from heat, hot surfaces, sparks, open flames, and other ignition sources.
- Use only in well-ventilated spaces.
- Ensure a fire extinguisher is readily available.
- Ground/bond container and receiving equipment.
- **Wear PPE.**
  - Eye/face protection
  - Cover skin to avoid contact.

#### SILICATE DENSIFIERS

- Use only in well-ventilated spaces.
- Ventilate closed spaces before entering them.
- Keep away from heat, hot surfaces, sparks, open flames, and other ignition sources.
- Ensure a fire extinguisher is readily available.

#### EPOXY URETHANE FLOOR SYSTEMS

- Keep away from heat, hot surfaces, sparks, open flames, and other ignition sources.
- Do not smoke nearby.
- Ground and bond container and receiving equipment.
- Use only non-sparking tools.
- Ensure a fire extinguisher is readily available.
- **Wear PPE.**
  - Gloves
  - Clothing
  - Eye protection
  - Face protection
  - Wash thoroughly after handling.

**Note:** Before using any tool, be sure to read the manufacturer's instructions. They take precedence over the information provided above.

**MANUAL SCREED**

Used to level the concrete to a predetermined height

**Hazards**

- Lower back strain from awkward postures
- Burns or skin sensitization from wet cement coming in contact with exposed skin

**Controls**

- Rotate between hand screeding and other tasks during the day.
- Change positions (i.e., sit or kneel using kneepads) when working at or near ground level.
- Stretch before working.
- **Wear PPE.**
  - Safety glasses or goggles
  - Gloves that protect skin from contact with wet cement (waterproof)
  - Steel-toed rubber boots

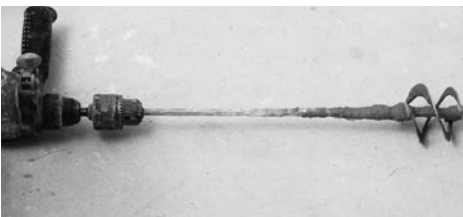
**MIXING DRILL**

Used for mixing epoxy, urethane, and other proprietary cementing materials

**Hazards**

- Being struck by or entangled with moving parts of the drill
- Injury resulting from unintentional start-up
- Electrocutation or shock

**Controls**

- Ensure the drill is equipped with a handle for proper grip.
- Always hold the drill firmly with both hands when carrying out work and ensure you have a secure footing.
- Tuck in loose clothing, jewelry, and long hair.
- Do not wind cables around any parts of the body.
- Use a ground-fault circuit interrupter (GFCI) to minimize risk of shock.

**MORTAR MIXER**

Used to mix dry or wet cement and mortar materials

**Hazards**

- Being struck by or entanglement with moving parts
- Exposure to exhaust from gas-powered engines

**Controls**

- Ensure protective guarding is in place while using the equipment.
- Use only in well-ventilated areas.
- Use care when dumping materials.
- Use lock-out/tagout procedures when cleaning or maintaining the equipment.

**Note:** Before using any tool, be sure to read the manufacturer's instructions. They take precedence over the information provided above.



## POWER RAKE

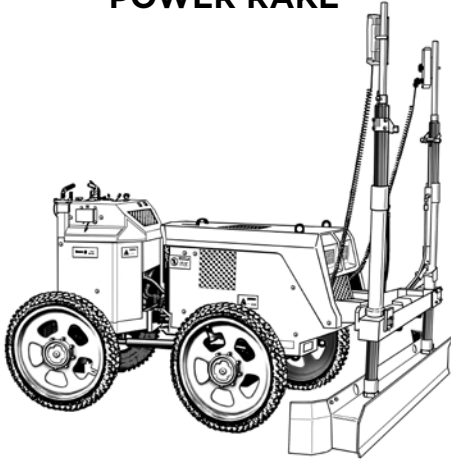

Used to place concrete to a predetermined height

### Hazards

- Carbon monoxide exposure from engine exhaust
- Being struck by moving equipment
- Noise exposure

### Controls

- Use in a well-ventilated space.
- Conduct a pre-operation inspection. (Refer to operator's manual.)
- **Wear PPE.**
  - Safety glasses or goggles
  - Hearing protection

## POWER WASHER



Used to clean concrete before re-sealing

### Hazards

- High-pressure water cutting through the skin
- Carbon monoxide exposure from gasoline-powered engines

### Controls

- Point the washer away from your body or other people at all times.
- Use in well-ventilated spaces.
- **Wear PPE.**
  - Rainsuit or other material suitable for environmental and process hazards
  - Face shield
  - Hearing protection

## POWERED ELEVATING WORK PLATFORM



Used to provide temporary access for inaccessible areas at height

### Hazards

- Machine tipping over
- Makeshift extensions
- Improper maintenance
- Moving while platform raised
- Getting on/off equipment
- Contacting overhead powerlines
- Being struck by moving equipment
- Striking other workers on the ground
- Being crushed between moving parts

### Controls

- In accordance with section 147 of the Regulations for Construction Projects (213/91), a worker who operates an elevating work platform shall, before using it for the first time, be given oral and written instruction on the operation and be trained to operate that class of elevating device. The instruction and training shall include:
  - The manufacturer's instruction
  - Load limitations
  - Instruction and hands-on demonstration of all controls
  - Limitations on the kinds of surfaces the device is designed to be used on
- The PEWP must:
  - Be designed by a professional engineer to meet the applicable National Standard (O. Reg. 213/91, s. 144)
  - Be tested according to the National Standard
  - Have guardrails
  - Have signs that are clearly visible to the operator indicating the rated working load, conditions of use, surface conditions required, warnings, direction of movement for each control, name and number of the National Standard and name and address of the owner
- Conduct a pre-operation inspection. (Refer to operator's manual.)
- A trained worker must inspect the PEWP daily before each use.
- Keep a maintenance and inspection log for each machine.
- Do not overload a PEWP.
- Use only on a firm, level surface.
- Use only in accordance with the manufacturer's instructions.
- Do not use it in any way that affects stability or endangers workers.
- Only move the PEWP when no workers are aboard or when they are protected by a safety belt attached to the platform in accordance with the manufacturer's operating instructions.
- Keep the operator's manual with the machine at all times.

**Note:** Before using any tool, be sure to read the manufacturer's instructions. They take precedence over the information provided above.

## QUICK-CUT SAW



**Used to cut contraction joints and rebar materials**

### Hazards

- Cuts from sharp blades
- Cuts from the saw kicking back when material is flimsy or not supported (wire mesh, rebar, etc.)
- Exposure to carbon monoxide from the motor when indoors or in poorly ventilated spaces
- Silica and dust from cutting concrete
- Excessive noise from the cutting blade and motor exceed (noise can exceed 100 decibels)
- Flying particles from dust, concrete chips, or the saw blade striking the eyes
- Electrical shock from contact with unprotected spark plugs

### Controls

- Make sure a pre-operation inspection is conducted (see operator's manual).
- Make sure a fire extinguisher is readily available.
- Fill the saw with the gasoline mixture outdoors in a well-ventilated area. Do not smoke around gasoline and use a funnel to prevent spills.
- Make sure the saw is regularly serviced and maintained.
- Use wet cutting techniques where required.
- Be sure the proper blades or disks are used and all guards are in place.
- Never start or operate the saw with anyone standing in front of it.
- Start the saw on a smooth, hard surface.
- When starting the saw or during cutting, always position and brace yourself.
- Be cautious around sharp edges left by cuts.
- To avoid kickback, secure and support the material to be cut, operate the saw in full throttle, and ease the blade into the cut.
- Inspect the blade before each use for signs of cracking, missing diamond segments, or other damage. Never use a damaged blade.
- **Wear PPE.**
  - Safety glasses or a face shield
  - Hearing protection
  - Respiratory protection

**Note:** Before using any tool, be sure to read the manufacturer's instructions. They take precedence over the information provided above.

**SCARIFIER**

Used to roughen and prepare existing concrete to receive bonded toppings

**Hazards**

- Dust exposure
- Noise exposure
- Carbon monoxide exposure from gasoline-powered engines

**Controls**

- Conduct a pre-operation inspection. (Refer to operator's manual.)
- Work in well-ventilated areas.
- **Wear PPE.**
  - Safety glasses or goggles
  - Hearing protection

**SHOT BLASTING**

Used to roughen and prepare concrete surfaces for applied finishes or bonded toppings

**Hazards**

- Noise exposure
- Flying particles
- Electrocutation

**Controls**

- Conduct a pre-operation inspection. (Refer to operator's manual.)
- Protect workers nearby.
- Equipment must be maintained by properly trained personnel.
- Ensure that the electrical connection has been installed by a qualified electrician
- **Wear PPE.**
  - Safety glasses or goggles
  - Hearing protection

**SHOVEL**

Used to spread, mix, or move concrete manually from one location to another

**Hazards**

- Lower-back pain from repetitive shovelling
- Back injury or other MSD from incorrect shovelling techniques (NOTE: The risk of an MSD increases as the weight of the material being shovelled increases.)

**Controls**

- Use proper shovelling techniques:
  - Stand with your shoulders and hips squarely facing the concrete.
  - Keep your back straight and bend at the hips.
  - To lift the load, keep one hand on the handle and move the other one as close to the blade as possible. Bend your knees and use your leg muscles to lift.
  - When moving the load, keep it close to your body. Turn your feet, walk to the new location, and drop the load. Do not twist your body and toss the load.
- Rotate between shovelling and other tasks during the day.
- Stretch regularly.
- If possible, check the consistency of the concrete. Wet concrete is heavier and can increase the risk of an MSD. If you do a slump test of the concrete, it should be at least 6 inches or higher.

**Note:** Before using any tool, be sure to read the manufacturer's instructions. They take precedence over the information provided above.

## SINGLE FLOAT AND TROWEL MACHINE



*Image courtesy of William Conway/Progress Photography*

**Used to consolidate and finish the slab surface**

### Hazards

- Noise exposure
- Being struck by spinning trowel handle
- Being cut by sharp edge of trowel or float shoes
- Fires from gasoline
- Falling when working on elevated slabs
- Protruding rebar, formwork, or other fixed protrusions that can catch and cause the machine to kick back
- Getting caught or tangled in the blades
- Overexertion injuries from lifting the machine
- Awkward postures leading to injuries in the shoulder and elbows from uneven handlebars
- Exposure to engine exhaust and carbon monoxide

### Controls

- Conduct a pre-operation inspection. (Refer to operator's manual.)
- Check that the "Emergency Stop" button works properly. Never disable it.
- Ensure guardrails are in place and secured.
- Never operate equipment with protective covers or guards removed.
- Always use both hands to operate the trowel.
- Never fill the fuel tank while the engine is running.
- Beware of hot engine parts.
- Never leave the trowel unattended while it is running.
- Do not leave tools or other equipment on the trowel while it is running.
- Do not wear loose clothing or jewellery.
- Do not smoke when filling or operating the engine.
- Do not operate when other workers are within swing radius of handle.
- Handle metal edges of float and trowel blades with care.
- Be aware of your surroundings. Always face the edge of the slab. Never operate the trowel machine with your back to the edge or toward the slab opening.
- Reduce speed when approaching slab edges.
- Remove engine drive belt when servicing equipment.
- When carrying machine, get assistance and lift carefully. Use a dolly or hoist whenever possible.
- **Wear PPE.**
  - Gloves
  - Hearing protection

**Note:** Before using any tool, be sure to read the manufacturer's instructions. They take precedence over the information provided above.

## SKILL SAW



Used for bulkhead construction

### Hazards

- Excessive noise
- Flying particles
- Fire
- Cuts from the saw blade or sharp materials
- Exhaust fumes from gas-powered saws being operated in poorly ventilated spaces
- Electrical shock from cords running through water
- Dust from cutting materials such as concrete or wood

### Controls

- Conduct a pre-operation inspection. (Refer to operator's manual.)
- Make sure a fire extinguisher is readily available.
- Inspect the saw before each use. Be sure that the lower retracting blade guard moves freely and that the blade is sharp enough for the task.
- Adjust the blade depth so that the lowest tooth does not extend more than 1/8" below the wood.
- When operating an electric saw outdoors or in wet locations, use a ground fault circuit interrupter (GFCI).
- Make sure cords are moved away from the cutting area.
- Always disconnect the power before changing the saw blade.
- To prevent kickback, secure and support the material to be cut and set the saw to full throttle before easing the blade into the cut.
- Never wear loose clothing, neck chains, scarves, or anything else that can get caught in the saw.
- Leave safety devices in place and intact on the saw.
- Never remove, modify, or defeat a guard. Keep your free hand away from the blade.
- When leaving saw unattended, disconnect it from the power source.
- **Wear PPE**
  - Safety glasses, goggles, or a face shield
  - Hearing protection
  - Respiratory protection

**Note:** Before using any tool, be sure to read the manufacturer's instructions. They take precedence over the information provided above.

## SLIP SHEET

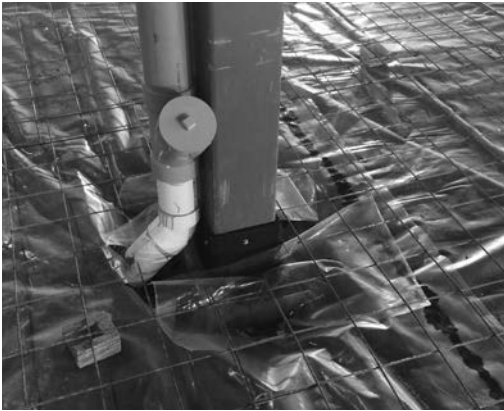

Used to reduce friction on the granular base

### Hazards

Slipping and falling while walking across a slip sheet after it has been placed

### Controls

- Avoid walking on a slip sheet after it has been placed.
- If you must walk across it, use extreme caution and concentrate on the task at hand.
- Do not carry anything when walking across a slip sheet in case you need your hands to break your fall.
- Be sure the soles of your safety boots are not worn. Over time, treads can wear off and the boot may not provide enough traction.
- Tape off the area to prevent workers from other trades walking across the slip sheet.

## TELEHANDLER (ZOOM BOOM)



Used to move heavy loads to and from inaccessible locations

### Hazards

- Being struck by moving equipment
- Carbon monoxide exposure from engine exhaust
- Being struck by falling materials that are hoisted in place
- Electrical contact with overhead powerlines
- Tipping over due to operating on uneven or uncompacted ground, on sloped grades, and on utility or temporary access covers

### Controls

- Conduct a pre-operation inspection. (Refer to operator's manual.)
- Keep the operator's manual with the machine at all times.
- Ensure that the equipment operator is guided by a signaller when the operator cannot see the path of travel.
- Ensure the load is secure and do not hoist materials over other workers.
- Do not let the boom touch an overhead energized electrical conductor. No part of a vehicle or its load shall encroach on the minimum distances to powerlines as outlined in the table below (O. Reg. 213/91, s.188).

Voltage Rating	Minimum Distance
750 to 150,000 volts	3 metres (10 feet)
150,000 to 250,000 volts	4.5 metres (15 feet)
More than 250,000 volts	6 metres (20 feet)

- Don't exceed the rated load capacity of the machine.
- Don't move the machine with a raised load.
- Equipment operators must have a record of training certificate to operate the machine.
- Operate the machine only in well-ventilated spaces.
- Check the ground conditions before operating the machine. Know the operation limits. Slopes and uneven or unstable surfaces can be hazardous.
- Don't speed. Drive slowly (at walking speed) around workers.

**Note:** Before using any tool, be sure to read the manufacturer's instructions. They take precedence over the information provided above.

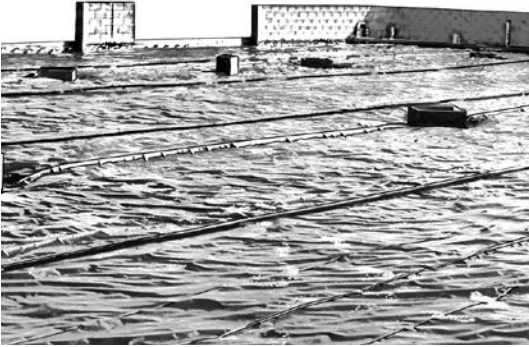
**VAPOUR RETARDER**

**Placed on the granular base under concrete to prevent moisture vapour from moving up through hardened concrete**

**Hazards**

Slipping and falling while walking across a vapour retarder after it has been placed

**Controls**

- Avoid walking on a vapour retarder after it has been placed.
- If you must walk across it, use extreme caution and concentrate on the task at hand.
- Do not carry anything when walking across a vapour retarder in case you need your hands to break your fall.
- Make sure the soles of your safety boots are not worn. Over time, treads can wear off and the boot may not provide enough traction.
- Tape off the area to prevent workers from other trades walking across the vapour retarder.
- Damage to a vapour retarder must be repaired before concrete work continues.

**VEHICLES (ON-SITE)****Hazards**

- Being struck by moving vehicles or equipment on site
- Carbon monoxide exposure from engine exhaust

**Controls**

- Conduct a pre-operation inspection. (Refer to operator's manual.)
- Designate a signaller to direct traffic. Never operate a vehicle in reverse without a signaller. (Refer to Appendix B for hand signals.)
- Beware of pinch points between vehicles and walls or columns.
- Do not stand behind moving vehicles.
- If walking around vehicles, always make eye contact with operator. Be aware of your surroundings.
- Ensure adequate ventilation.
- Do not walk beside, in front, or behind mobile equipment.
- **Wear PPE.**
  - Retroreflective vest
  - Hard hat
  - Safety boots

**Note:** Before using any tool, be sure to read the manufacturer's instructions. They take precedence over the information provided above.



## VEHICLES (PERSONAL)



Used to drive to and from work or around the worksite

### Hazards

- Motor vehicle incident
- Being struck by equipment, tools, or materials

### Controls

- **Slow down:** Drive within the speed limit and adjust your speed for weather and road conditions. Follow vehicles at a safe distance.
- **Relax:** In stressful driving conditions, take a deep breath and relax.
- **Stay alert:** Don't drive unless you are mentally and physically able to do so safely. If you become drowsy or uncomfortable while driving, pull over immediately and take a break.
- **Plan ahead:** Plan your route before you start out. If you're unfamiliar with where you're going, check your map or plot the route with GPS, before you start off.
- **Buckle up:** Wearing a seat belt is the law. Wearing your seat belt properly will dramatically increase your chances of surviving a motor vehicle collision.
- **Don't drink and drive:** Never drive while impaired or accept a ride with someone who you suspect may be impaired.
- **Secure your tools and equipment:** Prevent loose tools and equipment from moving around in the event of sudden stops or movements.

## VIBRATORY TRUSS SCREED



Used to level concrete to a predetermined height

### Hazards

- Overexertion from lifting screed
- Being struck by metal wire under tension at end of screed
- Carbon monoxide exposure from engine exhaust
- Getting fingers caught between screed and formwork
- Noise exposure
- Lifting equipment with the handle between your legs

### Controls

- Conduct a pre-operation inspection. (Refer to operator's manual.)
- Use a mechanical lifting device such as a dolly to lift the screed.
- If a mechanical lifting device is not available, make sure there are enough workers to lift screed.
- Ensure adequate ventilation.
- When lifting the screed, never place the lift handle between your legs.
- **Wear PPE.**
  - Safety glasses or goggles
  - Gloves
  - Rubber steel-toed boots
  - Hearing protection

**Note:** Before using any tool, be sure to read the manufacturer's instructions. They take precedence over the information provided above.

### WALK-BEHIND MANUAL VIBRATING SCREED (GAS OR ELECTRIC)



Used to level the concrete to a predetermined elevation

#### Hazards

- Carbon monoxide exposure from engine exhaust
- Fires from gasoline

#### Controls

- Conduct a pre-operation inspection. (Refer to operator's manual.)
- Make sure a fire extinguisher is readily available.
- Use in well-ventilated spaces. Introduce outdoor air or mechanical ventilation.
- Never fill the fuel tank while the engine is running. Beware of heat from engine.
- **Wear PPE.**
  - Safety glasses or goggles
  - Gloves
  - Steel-toed rubber boots

### WALK-BEHIND SAW



Used to create straight cracks at predetermined locations

#### Hazards

- Carbon monoxide exposure from engine exhaust
- Silica and dust from concrete
- Noise exposure
- Struck by injuries from segments of the blade being ejected from the machine

#### Controls

- Conduct a pre-operation inspection. (Refer to operator's manual.)
- Never operate equipment with protective covers or guards removed.
- Work in a well-ventilated area.
- Do not allow anyone to stand in front of the saw machine while it is in operation.
- **Wear PPE.**
  - Hearing protection
  - Safety glasses or goggles
  - Respiratory protection

**Note:** Before using any tool, be sure to read the manufacturer's instructions. They take precedence over the information provided above.

## WET CURING COVER



Used to harden the concrete surface. Wet curing covers such as polyethylene sheets are laid over new concrete

### Hazards

Slipping and falling while walking across a wet curing cover after it has been placed

### Controls

- Avoid walking on a wet curing cover after it has been placed.
- If you must walk across it, use extreme caution and concentrate on the task at hand.
- Do not carry anything when walking across a wet curing cover in case you need your hands to break your fall.
- Make sure the soles of your safety boots not worn. Over time, treads can wear off and the boot may not provide enough traction.
- Tape off the area to prevent workers from other trades walking across the wet curing cover.

## WIRE MESH OR REBAR



Used to reinforce concrete and create stability across floor joints

### Hazards

- Cuts from wire ends when placing and walking on wire mesh or rebar
- Tripping on wire mesh or rebar
- Overexertion from lifting and straightening rolls of wire mesh

### Controls

- Avoid walking on wire mesh and rebar whenever possible.
- Focus on your footing when walking on wire mesh or rebar. Do not run.
- Use gloves when handling wire mesh.
- Use assistance when carrying wire mesh.

# CHAPTER 6—OCCUPATIONAL HEALTH

## Workplace Hazardous Materials Information System (WHMIS)

The Workplace Hazardous Materials Information System (O.Reg. 860/90) or WHMIS, is a system to help workers know about and understand the hazards of certain products in the workplace. In February 2015, changes were made to WHMIS to make Canada's chemical hazard communication system similar to that of other countries.

The main components of the new WHMIS 2015 are:

- Educating workers about WHMIS
- Having labels on hazardous products
- Having Safety Data Sheets (SDSs) available on site.

### Worker Education

Employers are required by law to educate their workers about any hazardous products used in the workplace and on whichever system is used to identify those products. The transition period between the new WHMIS 2015 and the previous WHMIS 1988 will end on December 1, 2018. Until then, workers who may be exposed to hazardous products should receive training on both systems. However, this chapter will focus only on the new WHMIS 2015.

Concrete finishers should receive WHMIS training when they first start working in construction. Many workplaces require workers to take a refresher course in WHMIS every year.

If you use a hazardous product and don't know the dangers associated with it, talk to your supervisor and review the label and SDS.

### WHMIS Labels

Labels are an important component of WHMIS. They provide a brief description of the hazards associated with the product and the precautions to take when using the product, as well as other information.

There are two types of labels:

- Supplier labels (Figure 6-1)
- Workplace labels (Figure 6-2)

**Supplier labels** are labels that must be affixed by suppliers of hazardous products and include the following elements:

- **Product identifier** – should match the product identifier on the Safety Data Sheet (SDS)
- **Signal word** – either “Danger” (severe) or “Warning” (less severe)
- **Hazard statement** – a phrase assigned to a hazard class that describes the nature of the product's hazards
- **Precautionary statements** – describes recommended measures to minimize adverse effects resulting from exposure
- **Supplier identification** – the name, address, and telephone number of the manufacturer or supplier
- **Pictograms** – graphical symbols intended to convey specific hazard information visually.

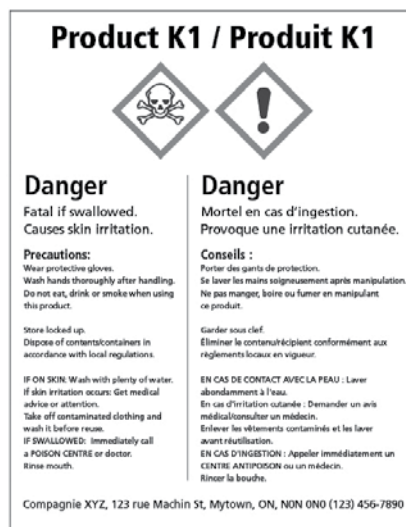

Figure 6-1: Supplier Label

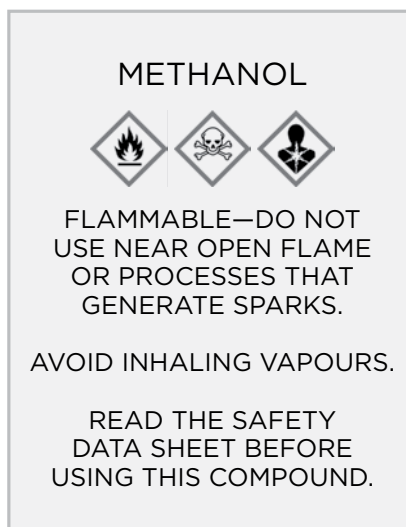

Figure 6-2: Workplace Label

**Workplace labels** are labels that the employer produces for use in their workplace only and contain the following elements:

- The identity of the product
- Information for the safe handling of the product
- A statement that a Safety Data Sheet (SDS) is available.

## Hazard Classes and Pictograms

Hazardous products fall into one or more hazard classes, each of which has a specific pictogram associated with it.

The new pictograms and hazard classes for WHMIS 2015 are shown in Figure 6-3. Order the WHMIS 2015 Poster (P003) from IHSA to help reinforce the training workers have received on the new system.

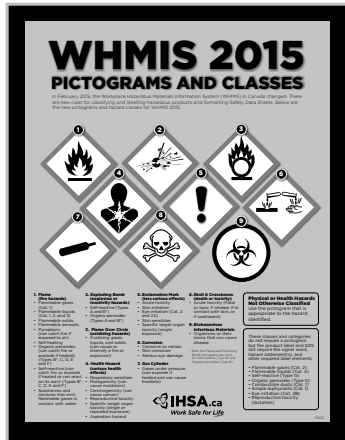

**Figure 6-3: WHMIS 2015 Pictograms and Classes**

## Safety Data Sheets (SDSs)

Safety data sheets must be available for every hazardous product in your workplace. The SDS provides more detailed information about the hazardous product. Below are the sections required to be displayed on a WHMIS 2015 SDS.

1. Identification
2. Hazard Identification
3. Composition Information on Ingredients
4. First Aid Measures
5. Fire Fighting Measures
6. Accidental Release Measures
7. Handling and Storage
8. Exposure Controls/Personal Protection
9. Physical and Chemical Properties
10. Stability and Reactivity

11. Toxicological Information
12. Ecological Information
13. Disposal Considerations
14. Transport Information
15. Regulatory Information
16. Other Information

## Carbon Monoxide

Carbon monoxide (chemical abbreviation: CO) is a colourless, odourless, and poisonous gas. It is produced by the incomplete burning of fuels. Workers who use gasoline-powered tools and equipment in buildings or semi-enclosed spaces are at risk of being exposed to carbon monoxide.

Carbon monoxide can accumulate rapidly, building up to dangerous or fatal levels within minutes. Since you cannot see or smell CO, you need a detector to warn if this hazard is present.

Breathing in CO gas interferes with your body's ability to use oxygen. Eventually, it deprives the body tissues of the oxygen that it needs for survival.

Tools, vehicles, and equipment powered by gasoline that can be a source of CO include those pictured below (Figure 6-4).

**Figure 6-4: Common Sources of CO**



**Concrete Trucks**



**Power Trowels**

*Image courtesy of William Conway/Progress Photography*





**Fuel-powered Lift Trucks**



**Scissor Lifts**

**Health Effects of CO**

CO causes the following effects in the body:

- Headache
- Fatigue
- Nausea
- Weakness
- Dizziness
- Confusion
- Shortness of breath
- Impaired vision or hearing
- Loss of consciousness and death.

Workers with heart and lung disease are particularly sensitive to CO exposure. In addition, smokers have higher levels of CO in their blood and may experience symptoms sooner than non-smokers.

**Preventing Exposure to CO**

- Avoid using fuel-powered equipment indoors whenever possible. Use electric-powered equipment, especially in confined spaces and poorly ventilated areas.
- If fuel-powered tools and equipment must be used indoors, avoid unnecessary idling, racing the engine, or braking erratically.
- Use personal CO monitors equipped with audible alarms to warn you when CO levels are too high. If dangerous levels are reached, evacuate the work area immediately. (See Table 6-1 for some suggested alarm settings.)

Alarm Setting	Airborne Concentration of CO (parts per million)	Precautions
Low	25 ppm (8-hour work shift)  17.5 ppm (10-hour work shift)	<ul style="list-style-type: none"> <li>• Turn off unneeded fuel-powered equipment and tools.</li> <li>• Increase ventilation by opening windows and doors or using a fan.</li> <li>• Record the alarm event in a log book and discuss it with your superintendent.</li> </ul> <p><b>If the alarm continues to sound or activates again after the precautions above have been taken:</b></p> <ul style="list-style-type: none"> <li>• Increase ventilation by opening more windows and doors or using additional fans where needed.</li> <li>• Have the company superintendent meet with the constructor to resolve fresh air ventilation issues before continuing work.</li> </ul>
High	75 ppm	<ul style="list-style-type: none"> <li>• Use the same precautions as for the “Low” alarm setting.</li> <li>• Turn off all fuel-powered equipment.</li> <li>• Limit the number of workers in the area while exhaust emissions are being ventilated.</li> <li>• Notify the company superintendent immediately.</li> <li>• Complete a CO Action Form.</li> </ul>

**Table 6-1: CO Alarm Settings**

- If compressors or generators are used, keep them outside.
- Make sure the work area is well-ventilated. Use air movers (large fans) and keep windows and doors open to bring fresh air inside. Note: This alone may not reduce CO to safe levels.
- Learn to recognize the symptoms of CO overexposure and keep an eye out for symptoms in yourself and co-workers.

- If you notice any symptoms, turn the equipment off immediately and go outdoors. Notify your supervisor. If symptoms persist, call 911 for medical attention. DO NOT drive or operate a motor vehicle.
- Inspect and maintain fuel-powered tools and equipment in accordance with the manufacturer's instructions to ensure they run properly and as cleanly as possible. Ensure that the air intake and fuel systems are working correctly.

Your company's Health and Safety Program should have written policies and procedures in place to control and monitor CO exposure in the workplace.

As of July 1, 2016, changes to section 47 of the Regulation for Construction Projects (213/91) will require maintenance and servicing of internal combustion engines and air testing to ensure that the concentration of CO does not exceed the Occupational Exposure Limit (OEL). OELs restrict the amount and length of time a worker can be exposed to hazardous chemicals in the air.

The TWA is the amount of chemical substance in air that a worker may be exposed to averaged over an 8-hour workday or 40-hour work week. If exposure limits are kept below the TWA, adverse health effects should not occur. The exposure limit for CO is three times the TWA for any period of 30 minutes and five times the TWA at any time.

## Temporary Heaters

Temporary heaters are used to heat the workplace and to protect and cure materials. When building openings are sealed up to retain heat, the amount of fresh air ventilation is reduced. This can expose workers to dangerous levels of airborne CO gas. Never use open-flame heaters in interior spaces without adequate ventilation (Figure 6-5).



**Figure 6-5: Open-flame Heaters Must Have Adequate Ventilation**

Section 49 of the Construction Projects regulation (213/91) requires the exhaust from heaters to be discharged outdoors and not into an enclosed space. Other ways to prevent CO exposure from temporary heaters are listed below.

- Make sure that the heater is in good shape and has been maintained in accordance with the manufacturer's instructions. Check to see when the heater was last serviced and tested. (It should be done at least every 12 months.)
- Be sure you understand the symptoms of CO exposure, the emergency procedures in case a worker experiences symptoms, and ways of preventing CO buildup.
- Make sure CO levels in the air are monitored. A variety of industrial-grade monitors are available to purchase or rent. Units designed for in-home use are not suitable for the workplace.
- Use an indirect-fired heater for heating the work area rather than a direct-fired heater (e.g., open-flame or closed-flame heater). Indirect-fired heaters vent combustion by-products (including CO) outdoors while directing the heated air inside.

## Isocyanates

Isocyanates are used to produce polyurethane products such as sealants and joint fillers that protect and fill cracks in concrete. Isocyanates are irritants and can be absorbed through the eyes, skin, and lungs.

Exposure to isocyanates can lead to "sensitization." A worker can become sensitized at any time from inhaling or getting isocyanates on the skin. After that, any exposure can lead to a very severe asthma attack during which the lungs constrict, making it very difficult to breathe. Isocyanates on the skin can cause skin irritation as well.

## Preventing Exposure to Isocyanates

- Make sure you receive WHMIS training. Consult the Safety Data Sheet (SDS) for the product and familiarize yourself with the health effects, the ways to control exposure, and the handling and storage procedures.
- Keep the area clear of workers who are not protected by PPE. Use barriers and warning signs.
- Ensure adequate ventilation to prevent vapours from accumulating.
- Store materials in tightly sealed containers when not in use.

- Use the right kind of personal protective equipment (PPE) when handling products containing isocyanates. Refer to the SDS. PPE may include
  - Supplied-air respiratory protection (or other kinds as described in the SDS)
  - Impermeable gloves such as neoprene, nitrile, or other kinds described by the SDS
  - Eye protection such as chemical goggles for handling the product in drums
  - Coveralls or other clothing to protect the skin from contact.
- Follow good hygiene practices—wash hands and face before eating, drinking, or smoking.
- Clean up spills quickly while using the right PPE.

## Silica



**Figure 6-6: Silica Dust from Grinding Concrete**

Crystalline silica is a basic component of soil, rock, and sand. It is found in cement and concrete as well as many other common construction materials.

When silica is inhaled it travels into the deep parts of the lungs, where it can cause damage. Because silica cannot be seen with the naked eye, you may not see any dust in the air. Therefore you should always take precautions to protect yourself and others whenever you are working with materials containing silica.

Silica can cause a variety of diseases, including

- **Silicosis**—an inflammation and scarring of the lungs that makes it difficult to breathe and is often fatal
- **Chronic obstructive pulmonary disorder (COPD)**—a combination of chronic bronchitis and emphysema that is often fatal
- **Scleroderma**—an autoimmune disease that causes hardening of the skin and sometimes of the vital organs
- **Lung cancer.**

Silica exposure can occur from any operation where dust containing silica is generated. That could include

- Mixing cement or hardeners
- Grinding concrete
- Scarifying
- Cutting with a saw
- Any other operations in which concrete is cut, broken, ground, or chipped (Figure 6-6).

There is no cure for most of the diseases caused by silica. The only way to prevent them is to avoid being exposed to it.

## Preventing Exposure to Silica

- Use water and wet working methods to keep the silica dust that is generated out of the air.
- If you must cut concrete, use a wet-cut saw.
- Only mix cement in well-ventilated areas.
- Work upwind from sources of dust. Allow the wind to carry the dust away from you.
- Use tools and equipment that have dust collectors or water attachments.
- Use respiratory protection. Depending on the concentration of dust, an N95 filtering facepiece respirator may be suitable.
- Clean up the workplace frequently to prevent a buildup of dust and silica. Do not dry-sweep or use compressed air to clean.
- Wash your face and hands before eating, drinking, or smoking and before going home.

For more detailed information about silica controls, see the Ministry of Labour's guideline *Silica on Construction Projects* at: [www.labour.gov.on.ca/english/hs/pubs/silica](http://www.labour.gov.on.ca/english/hs/pubs/silica)

## Heat Stress



**Figure 6-7: Drink Water to Prevent Heat Stress**



Heat-related illnesses can result from working either outdoors or indoors in hot weather or from working near hot processes.

Exposure to excessive heat can cause dehydration and a rise in body temperature. When that happens, the following illnesses can develop:

- Heat rash (plugged sweat glands)
- Heat cramps (caused by loss of salt from sweating)
- Heat exhaustion
- Heat stroke (very serious—you can die).

See Table 6-2: Heat-Related Illness and Management for more information on the causes, symptoms, treatment and prevention of these heat-related illnesses.

## Preventing Heat Stress

- Drink 1 cup of cool water every 20 minutes even if you are not thirsty (Figure 6-7).
- Take a rest break if you feel unwell.
- Watch for signs of heat stress in other workers.
- Use a water mist to cool workers.
- Wear light coloured clothing.
- Consider rescheduling of work to cooler periods of the day.
- If you take prescription drugs consult your physician before working in hot environments.
- Call for medical assistance immediately if someone faints.

## Cold Stress

When you are cold, blood vessels in your skin, arms and legs constrict, decreasing the blood flow to your extremities. This helps your vital organs stay warm, but you risk frostbite in your extremities.

Frostbite means that your flesh is freezing. Blood vessels are damaged and the reduced blood flow can lead to gangrene. Frostbitten skin looks waxy and feels numb. Once tissue becomes hard, it's a medical emergency.

Another health hazard associated with cold stress is hypothermia (also called exposure). This occurs when your body loses heat faster than it can produce it, causing an abnormally low core temperature.

Moderate symptoms of hypothermia include:

- Blue lips and fingers
- Slow breathing and heart rate
- Disorientation and confusion
- Poor coordination

In more severe cases, the person may be unconscious with no detectable pulse or breathing. Although the person may appear dead, always assume they are alive.



**Figure 6-8: Wear Warm Clothes to Prevent Cold Stress**

## Preventing Cold Stress

- Wear several layers of clothing rather than one thick layer to capture air as an insulator.
- Wear synthetic fabrics next to the skin to “wick” away sweat.
- If conditions require, wear a waterproof or wind-resistant outer layer.
- Wear warm gloves.
- Wear hats and hoods. You may need a balaclava.
- Tight-fitting footwear restricts blood flow. You should be able to wear either one thick or two thin pairs of socks.
- If your clothing gets wet at 2°C or less, change into dry clothes immediately and get checked for hypothermia.
- If you get hot while working, open your jacket but keep your hat and gloves on.
- Take warm, high-calorie drinks and food.

**Table 6-2: Heat-Related Illness and Management**

Illness	Cause	Symptoms	Treatment	Prevention
<b>Heat Rash</b>	Hot humid environment leading to plugged sweat glands	Red, bumpy rash with severe itching	Change into clean, dry clothes often, and avoid hot places. Rinse skin with cool water.	Wash regularly to keep skin clean and dry.
<b>Heat Cramps</b>	Heavy sweating from strenuous physical activity drains a person's body of fluid and salt, which cannot be replaced just by drinking water. Cramps occur from salt imbalance resulting from failure to replace salt lost from heavy sweating.	Painful cramps, usually in the most-worked muscles (arms, legs, or stomach), which start suddenly at work or later at home. Heat cramps are serious because they can be a warning of other more dangerous heat-induced illnesses.	Move to a cool area and loosen clothing. Gently massage and stretch affected muscles. Drink cool salted water (1/4 to 1/2 tsp. salt in 1 litre of water) or commercial fluid electrolyte replacement beverage. If the cramps are severe or don't go away after salt and fluid replacement, seek medical aid. Salt tablets are not recommended.	Reduce activity and/or exposure to heat. Drink fluids regularly. Workers should watch one another for symptoms that often precede heat stroke.
<b>Fainting</b>	Fluid loss, inadequate water intake, and standing still can result in decreased blood flow to brain. Usually occurs in people who aren't acclimatized to the heat.	<ul style="list-style-type: none"> <li>• Sudden fainting after at least 2 hours of work</li> <li>• Cool, moist skin</li> <li>• Weak pulse</li> </ul>	GET MEDICAL ATTENTION. Assess the need for CPR. Move to a cool place, loosen clothing, and make the person lie down. If the person is conscious, offer sips of cool water. Fainting may also be due to other illnesses.	Reduce activity and/or exposure to heat. Drink fluids regularly. Move around and avoid standing in one place for too long. Workers should watch one another for symptoms that often precede heat stroke.
<b>Heat Exhaustion</b>	Fluid loss and inadequate salt and water intake causes the body's cooling system to start to break down.	<ul style="list-style-type: none"> <li>• Heavy sweating</li> <li>• Cool, moist skin</li> <li>• Body temperature over 38°C (100°F)</li> <li>• Weak pulse</li> <li>• Normal or low blood pressure</li> <li>• Tired and weak</li> <li>• Nausea and vomiting</li> <li>• Thirsty</li> <li>• Panting or breathing rapidly</li> <li>• Blurred vision.</li> </ul>	GET MEDICAL ATTENTION. This condition can lead to heat stroke, which can kill. Move the person to a cool shaded place, loosen or remove excess clothing, provide cool water to drink, fan them, and spray with cool water. Do not leave the person alone.	Reduce activity and/or heat exposure. Drink fluids regularly. Workers should watch one another for symptoms that often precede heat stroke.
<b>Heat Stroke</b>	If a person's body has used up all its water and salt reserves, it will stop sweating. This can cause the temperature to rise. Heat stroke may develop suddenly or may follow from heat exhaustion.	<p>High temperature (over 41°C (100°F)) and any one of the following:</p> <ul style="list-style-type: none"> <li>• Weak, confused, or upset</li> <li>• Acting strangely</li> <li>• Hot, dry, red skin</li> <li>• Fast pulse</li> <li>• Headache or dizziness.</li> </ul> <p>In later stages, a person may pass out and have convulsions.</p>	CALL AN AMBULANCE. This condition can kill a person quickly. Remove excess clothing from the person, fan them, and spray them with cool water if they are conscious.	Reduce activity and/or heat exposure. Drink fluids regularly. Workers should watch one another for symptoms that often precede heat stroke.

## Hygiene

Workers on construction sites are often exposed to infectious diseases because of unsanitary conditions in and around toilets and clean-up facilities. Having a well-maintained hand-washing facility not only helps eliminate infectious diseases but also keeps concrete finishers safe from some of the toxic dusts and chemicals they often encounter.

Hand washing helps remove toxic materials from the skin, thereby preventing workers from ingesting hazardous chemicals and developing skin reactions. Concrete finishers should remember to wash their hands:

- after using the toilet
- before eating, drinking, handling food, or smoking
- after coughing or blowing their nose
- after contact with chemical agents.

Even if hand sanitizer is provided, workers still need soap and water to remove dirt and hazardous chemicals from their skin.

Constructors are legally required to provide toilets, urinals, and clean-up facilities for workers before work starts (O. Reg. 213/91, s.29). There must also be reasonable access to these facilities.

Suppliers must provide toilets and clean-up facilities that are in good condition (OHSA, s. 31). The facilities must comply with section 29.1 of the construction regulation.



**Figure 6-9: Facilities Must Be Clean and Sanitary**

## Preventing Hygiene Hazards

- Toilets can be either water-flush toilets that are connected to a sanitary sewer or chemical flush toilets.
- Never stand under a portable toilet as it is being hoisted in place.
- There is a specified minimum number of toilets or urinals based on the number of workers on the site.
- Unless the facilities are used by one worker at a time, female workers will need separate facilities.
- Clean-up facilities should have hot and cold running water where reasonably possible and either paper towels (with a waste receptacle) or a hand dryer.
- If running water is not possible, a hand cleanser with either paper towels (and a waste receptacle) or a hand dryer is acceptable.
- There should be an adequate number of wash basins (no fewer than half the number of toilets).
- Facilities should be well-lit, heated (if possible), ventilated, and kept in good condition at all times.
- Facilities should be regularly serviced, cleaned, and sanitized and records should be kept showing when this was done (Figure 6-9).
- Workers should report any unsanitary conditions to their supervisor.

## Impairment

Workers who are impaired because of illness or drug and alcohol use may overlook safe work practices and create hazards for themselves and others.

## Preventing Impairment Hazards

- Report unsafe workers to your supervisor immediately.
- Do not work around impaired workers.
- Beware of the effects of medication on your ability to work safely. Consult your physician.
- Do not use illicit drugs or alcohol on the jobsite at any time.
- Talk to your supervisor if you feel unwell.
- Assistance may be available from your workplace or labour representative.

For more information, visit [ihsa.ca/products](http://ihsa.ca/products) and order or download *Dangerous Decisions: The Real Costs of Substance Abuse in the Workplace* (IHSA048).

## Noise

Concrete finishers may be exposed to noise from a variety of sources, including tools and equipment (Table 6-3). They may also be exposed to noise from other trades on the jobsite or from sources outside the workplace.

**Table 6-3: Noise Levels of Tools and Equipment**

Tool/Equipment	Noise Level
Single trowel machine	86 dBA
Double trowel machine (24HP)	92 dBA
Concrete buggy	87-94 dBA
Concrete saw	97-103 dBA
Soff-cut (early-entry) saw (9HP)	90 dBA
Walk-behind saw	93 dBA
Power washer (gas-powered)	93 dBA
Compressor	85-104 dBA

Over time, exposure to noise can cause the following problems:

- Noise-induced hearing loss
- Tinnitus (ringing in the ears)
- High blood pressure
- Fatigue.

Noise-induced hearing loss (NIHL) is the most common occupational disease suffered by construction workers in Alberta. Because it often happens gradually, workers may not realize that loud noise from their job is damaging their hearing. By the time they do realize it, it's too late—the damage is permanent and can't be reversed.

Protecting the hearing of workers should be part of a company's health and safety program. Such a program should include:

- Testing noise levels in workplace to determine how loud it is and how much the workers are exposed to it (Figure 6-11)
- Putting controls in place to prevent noise from being generated in the workplace or from entering it

- Audiometric testing to detect early changes to the hearing ability of workers and to determine the effectiveness of current noise prevention measures
- Educating workers on the health effects of noise, the procedures for protecting their hearing during specific job tasks, and the selection, care, use, and fit of hearing protection devices.

In addition to hearing loss, noise can cause other hazards by interfering with communication and preventing workers from hearing alarms or warning sounds.

### Did you know?

On July 1, 2016, a new noise regulation came into effect. O. Reg. 381 under the OHSA sets out a maximum time-weighted average limit of 85 dBA of noise exposure over an 8-hour work shift and requires employers to implement controls and to provide adequate training and instruction on hearing protection devices



**Figure 6-11: Testing Noise Levels in the Workplace**

### Preventing Exposure to Noise

Although hearing loss cannot be cured, it can be prevented. The best way of preventing exposure to noise is to control it at the source or along the path. That way, everyone in the area is protected from noise. These types of controls include the following:

- Replace noisy tools and equipment with quieter ones. In general, newer equipment is quieter than older equipment and electrical tools are quieter than pneumatic or gas-powered ones.
- Follow a maintenance schedule for tools and equipment.
- Move sources of loud noise away from workers or move workers away from the noise.
- Retrofit equipment to make less noise (e.g., add noise absorbers to older equipment).
- Install noise barriers between the source of the noise and the workers.
- Use sound absorbers to block or reduce noise levels.
- Enclose noisy work processes or equipment such as generators and compressors in an insulated box or room.

If it is not possible to control noise at the source or along the path, the only other alternative is to control noise at the worker.

- Rotating workers between job tasks can ensure that they are not exposed to loud noise for longer than the maximum recommended time.
- Warning signs can let workers know when they need to take precautions against noise exposure.
- Having standardized work rules in place can ensure that every worker follows the proper procedures to protect themselves against noise.

Wearing hearing protection devices such as earplugs and earmuffs are one of the most common ways to protect workers from noise. However, personal protective equipment should be considered a last resort.

For more information on the different types of hearing protection devices and how to use them, refer to Chapter 8: Personal Protective Equipment.

## CHAPTER 7—MUSCULOSKELETAL DISORDERS

Musculoskeletal disorders (MSDs) are injuries of the following parts of the body:

- Muscles
- Tendons
- Ligaments
- Nerves
- Cartilage
- Blood vessels
- Joints
- Spinal discs.

MSDs are not usually the result of any instantaneous or acute event (such as a slip, trip, or fall) but reflect a more gradual or chronic development. Over time,, exposure to MSD risk factors can cause a variety of disorders, such as:

- Back pain
- Carpal tunnel syndrome in the wrists and hands
- Epicondylitis (tennis elbow)
- Rotator cuff disorder or syndrome in the shoulder
- Bursitis in the knees and shoulders.

### MSD Risk Factors

MSDs often take time to develop. Disorders usually arise from exposure to certain risk factors, which can include:

- Forceful exertion
- Awkward positions
- Repetitive tasks.

When aggravating factors are also present, an MSD may become more severe. Aggravating factors can include:

- Hand-arm and whole-body vibration
- Contact stress
- Cold temperatures.

The tasks listed in Table 7-1 are often done by concrete finishers and can increase the risk of an MSD if precautions are not taken.

**Table 7-1: MSD Hazards from Concrete Finishing Tasks**

Task	MSD Hazard
<ul style="list-style-type: none"> <li>• Using concrete vibrators</li> <li>• Using hand tools such as hammers and shovels</li> </ul>	<ul style="list-style-type: none"> <li>• Repetitive motions and vibration</li> <li>• Repetitive motions and overexertion from shovelling heavy concrete can cause lower-back pain.</li> </ul>
<ul style="list-style-type: none"> <li>• Moving wheelbarrows</li> <li>• Using concrete come-alongs</li> <li>• Carrying materials required for the job</li> <li>• Shovelling</li> <li>• Holding concrete pump hoses</li> </ul>	Overexertion due to pushing, pulling, lifting, lowering, or carrying tools, equipment, and materials can cause injuries to the lower back and other parts of the body.
<ul style="list-style-type: none"> <li>• Using manual bull floats</li> <li>• Applying caulking</li> <li>• Hand trowelling</li> <li>• Hand screeding (Figure 7-1)</li> </ul>	Prolonged bending at the waist, squatting, and kneeling can cause back, knee, arm, and wrist injuries.



**Figure 7-1: Hand Screeding**

## Preventing MSDs



**Figure 7-2: Hand Cart for Moving Materials**

- Actively assess the job and implement controls before starting work to avoid overexertion and awkward positions.
- When possible, use material-handling equipment such as carts, dollies, pallet jacks, or lift trucks to carry tools, equipment, and materials (Figure 7-2).
- Plan ahead to minimize material handling.
- When moving equipment, use a ramp to allow easy handling on stairs and uneven walkways.
- Consider using a powered screed whenever possible when spreading or distributing (floating) the concrete. It will help you reduce awkward positions (e.g., bending at the waist, squatting, and kneeling).
- When choosing power screeds, make sure you have the right machine for the job.
- If possible, use a powered edge trowel to reduce bending over. Use a manual hand trowel around the edges and inner corners.
- Use a lifting tool to pull up the wire mesh when spreading concrete.
- Use a lift truck to distribute pallet loads.
- Use shoulder pads when a heavy object cannot be transported with a cart or other transport device. Carrying a heavy object on the shoulder often causes excessive pressure on a small area. Shoulder pads can reduce the contact stress to the shoulder.



**Figure 7-3: Get Help Carrying Heavy Loads**

- Get help from a co-worker if a load is too heavy for you to handle on your own (Figure 7-3). If possible, divide the load into smaller loads. This puts less stress on your back even if you have to make more trips.
- Do not overload wheelbarrows with concrete and gravel. Make sure the wheels are in good condition.
- Rotate certain jobs (e.g., spreading concrete manually, floating, or finishing) among different members of the crew.
- If you must carry the materials, carry only a single box or bag at a time. Use small bags and buckets of material (23 kg or 50 lb maximum).
- Place heavy materials close to the work location to reduce the carrying distance.
- Know your capabilities and don't exceed them.
- Lifting a load from the floor or from below standing knuckle level can put severe stress on your back. Store objects between standing knuckle level and standing shoulder level.
- If you must lift objects or materials from the floor, use proper lifting techniques (Figure 7-4):
  1. Face in the direction of the object.
  2. Take a balanced stance with feet about shoulder width apart.
  3. Squat down and get as close to the object as you can.
  4. Lift gradually, using your legs and not your back.
  5. Once you're standing, change direction by pointing your feet in the direction you want to travel. Avoid twisting at the waist while carrying the load.



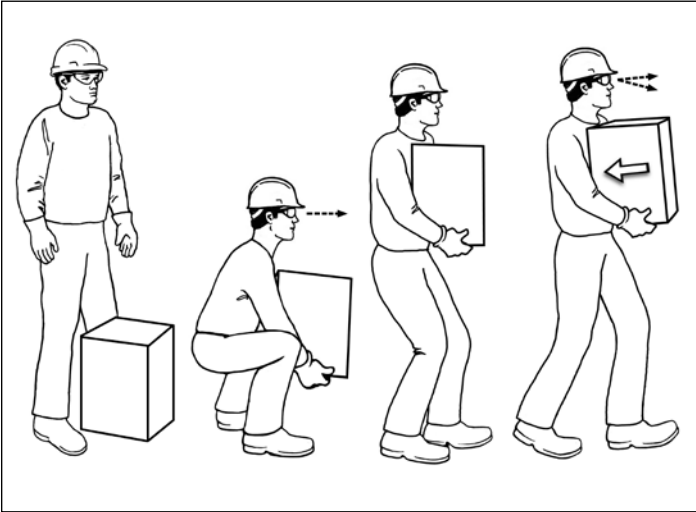

**Figure 7-4: Proper Lifting Technique**

- Constantly working on the floor can result in injuries to your back, hips, and knees because you usually have to kneel and bend forward. When possible, work at a height between your hips and shoulders. Try raising your work area by using a workbench.
- During breaks, give your muscles a rest (e.g., sit on a comfortable chair with a back rest).
- Switch periodically between kneeling, squatting, and sitting
- If you cannot avoid working on or near the floor, use high-quality kneepads and stand up to take a break from kneeling whenever possible. Kneepads with rollers or a kneeling creeper (such as Master Rac) will reduce friction and allow you to move around easily. (NOTE: Kneepads distribute force over a larger area of the knee's surface, but don't reduce the forces on the knee joint itself.)
- Exercising and stretching can ease strain on your body. See Appendix A for stretching exercises to do before you start work.
- Switch regularly between screeding and other tasks and between hand troweling and other tasks.
- Use good body positioning when rodding and spreading concrete. For example, a wide stance is more stable and powerful and is easier on the back.
- When pulling a screed rod or a rake, it is less awkward to stand with one foot in front of the other than with the feet closer together. There is less bending, and your balance is better.
- Never pour more than the length of the screed bar ahead of the placing crew. This allows for an area where "high material" can be pulled, and it creates a place for extra material when needed. It also allows enough room for workers to do their jobs without running into one another. You may start pouring ahead of this bay, but leave an open area.
- Pour the shoulders first. Always start with the wall line (if there is one) or cold joint so workers can address these before the placing/rodding crew arrives. Then fill in the middle of the bay just as the screed crew arrives. This procedure has the following advantages:
  - Working together with the hose or chute tender will eliminate excessive material handling and movement.
  - Less fatigue means fewer injuries and better morale.
  - The more efficient the work process, the more productive the job.
- Keep the work area organized and make sure that walking/working areas are clear of obstructions.





# CHAPTER 8—PERSONAL PROTECTIVE EQUIPMENT

Personal protective equipment (PPE) is designed to protect workers from physical dangers and/or health hazards. Equipment such as hard hats, safety glasses, and safety boots are designed to prevent an injury or reduce the severity of an injury if one occurs. Other PPE such as hearing and respiratory protection are designed to prevent illnesses and damage to the worker's health.

It is important to remember that PPE only reduces the risk—it does not remove the hazard. The best way of protecting workers is to control the hazard at the source or along the path. However, if that is not possible, controls need to be put in place at the worker. This concept is referred to as the hierarchy of controls (Figure 8-1).

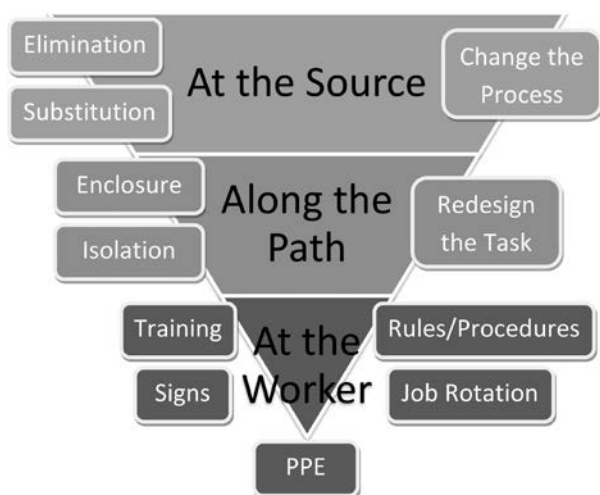

**Figure 8-1: Hierarchy of Controls**

## Hearing Protection

Noise is the number-one cause of occupational disease in construction. In Chapter 6: Occupational Health, we pointed out some common sources of noise on the job. We explained that if it is not possible to control noise at the source or along the path, you need to control it at the worker.

Personal protective equipment (PPE) such as earplugs and earmuffs are the most common ways to control noise exposure at the worker. In this chapter, you will learn how to select, use, care for, and fit a hearing protection device (HPD).

## Choosing Hearing Protection Devices

There are many types of HPDs available (Figure 8-2). Make sure you choose a type that you can wear comfortably for long periods of time. Earplugs will be somewhat uncomfortable at first. However, within about two weeks the discomfort will disappear. For short duration tasks, consider using earmuffs, which don't take as much time to put on as ear plugs.

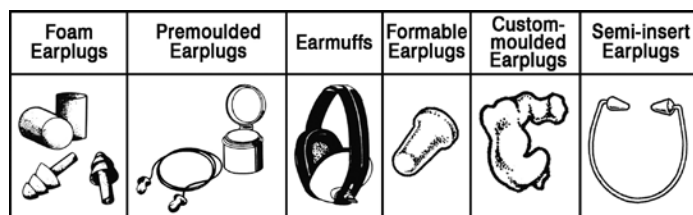

**Figure 8-2: Types of Hearing Protective Devices**

Earplugs work by plugging the ear canal to reduce the amount of noise that enters the ear. Earmuffs keep noise out of the ear by covering the entire outer part of the ear.

## Care and Use

Follow the tips below for selecting, using, caring for, and fitting HPDs.

- Wear hearing protection for loud tasks even if they only last a short time. The effectiveness of HPDs is drastically reduced if they are removed even for short periods of time.
- Follow the manufacturer's instructions for inserting or putting on HPDs.
- Readjust your earplugs or earmuffs regularly to maintain a tight seal. Vibration or constant movement of the head can lead to air leaks.
- The size and shape of a person's ear canal, jaw, and head may affect the fit of earmuffs and earplugs. To accommodate these differences, make HPDs available in various shapes and sizes.
- The headphones and earphones that are used with radios, MP3 players, smartphones, etc. must NOT be used as hearing protection.

- When using earplugs:
  - Make sure your hands are clean before putting in the plugs.
  - If small openings or wrinkles are formed in the plug when rolling it, the plug will be less effective.
  - Wash reusable earplugs after each use with warm soapy water. When not in use, keep them in a clean, dry container.
  - Follow the manufacturer's instructions for inserting the earplugs.
- When using earmuffs:
  - The ear cups must fully cover the outer part of your ears.
  - You should feel a slight pressure around your ears when you are wearing earmuffs. If you do not, they may be too loose and may allow noise to enter. Adjust the tension of the headband.
  - Hair, especially long hair and facial hair, can interfere with the seal of an earmuff.
  - Do not modify earmuffs in any way.
  - Follow the manufacturer's instructions for proper use.

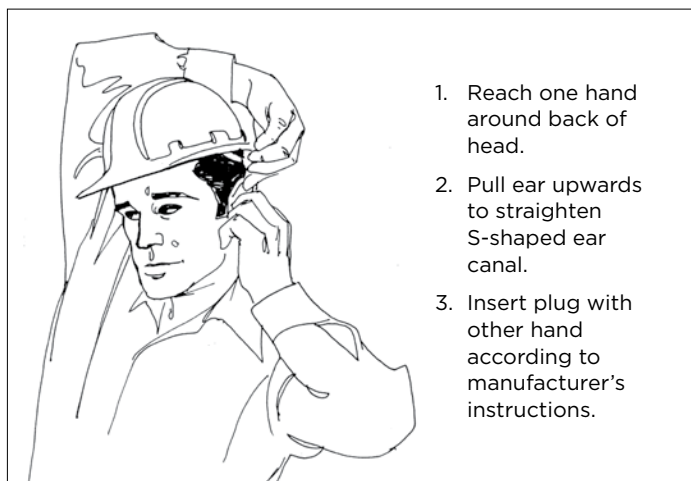

**Figure 8-3: Procedure for Inserting Earplugs**

1. Reach one hand around back of head.
2. Pull ear upwards to straighten S-shaped ear canal.
3. Insert plug with other hand according to manufacturer's instructions.

### Did you know?

The new Noise Regulation (O. Reg. 381) came into effect on July 1, 2016. It will require employers to provide adequate training and instruction on hearing protection devices.

## Eye Protection

Proper eye protection, combined with safe work procedures, can reduce the risk of an eye injury. Concrete finishers may encounter the following eye hazards:

- **Flying Objects** – A piece of metal can pierce the cornea and eyeball and possibly cause the loss of an eye.
- **Dust** – Dust can cause irritation resulting in a corneal ulcer, which is a breakdown of corneal tissue causing red, watery eyes or a discharge.
- **Abrasive** – Sand can cause a corneal abrasion, which can cause blindness.
- **Glare** – Glare can make it difficult to see and can be extremely tiring to the eye.

### Choosing Eye Protection

When choosing eye protection, be sure that it is properly fitted and is industrial quality. IHSA recommends that your safety glasses meet the requirements of CSA Standard Z94.3 Class 1. Look for the CSA logo (Figure 8-4) and the manufacturer's ID mark on both the frame and the lens. These mean that the safety glasses are industrial quality.

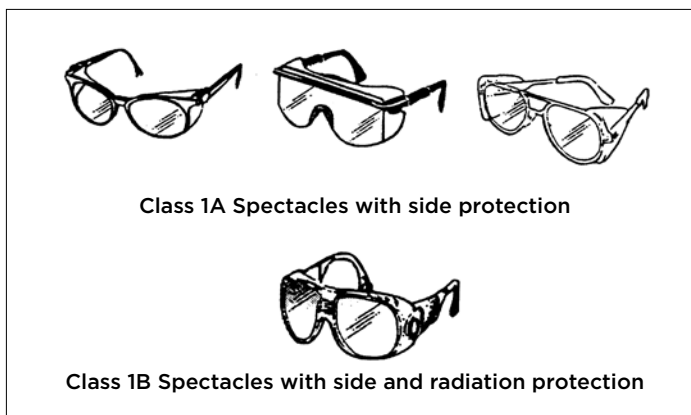

**Figure 8-4: CSA Logo**

The following kinds of eye protection are available for different hazards.

1. Class 1 – Spectacles
2. Class 2 – Goggles
3. Class 3 – Welding Helmets
4. Class 4 – Welding Hand Shields
5. Class 5 – Hoods
6. Class 6 – Face Shields
7. Class 7 – Respirator Facepieces

**Spectacles** (Class 1 Eye Protection) must have side shields (Figure 8-5). Spectacles are intended to prevent injury to the eyes from flying objects such as concrete and dust, and from glare or stray light.



**Figure 8-5: Types of Class 1 Eye Protection**

**Goggles** (Class 2 Eye Protection) come in vented and non-vented models (Figure 8-6). Vented models have small openings to allow air into the goggles to reduce fogging. However, they are not good for keeping out dust and splashes, which can get in through the openings. Non-vented and indirect-ventilated goggles are better at keeping out liquids and dusts.

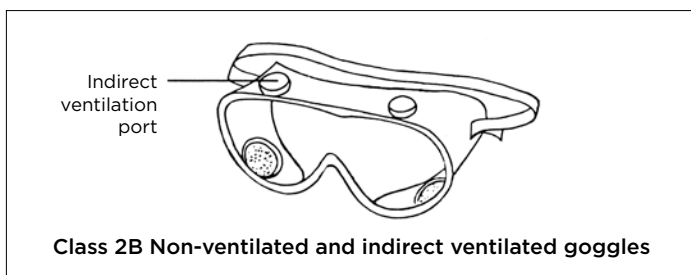
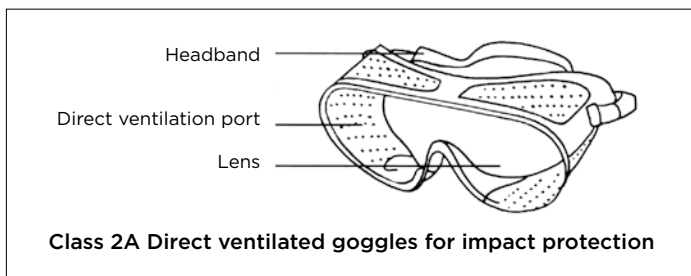

**Figure 8-6: Types of Class 2 Eye Protection**

**Care and Use**

Like all equipment, eye protection must be cared for and inspected to make sure it works properly.

- Inspect lenses regularly for pitting and scratches, which can make it hard to see clearly.
- Replace scratched or pitted lenses and loose frames or arms with original manufacturer’s parts.

- Clean lenses with clear water to remove abrasive dust. Cleaning dry lenses can scratch them.
- Anti-fog solutions can be used on glass or plastic lenses.
- Handle frames with care, and check daily for cracks and scratches.
- Never throw eye protection into toolboxes—they can get scratched or damaged.
- Keep spectacles in their protective cases when they are not being used.

**Contact Lenses**

Contact lenses should not be worn on construction sites. They may be difficult to keep clean when they have to be removed or inserted. If dust and dirt get behind a contact lens, they will cause discomfort and make it hard to see.

If contact lenses must be worn to correct an eye defect, the worker should obtain a written statement from an ophthalmologist or optometrist saying that the person needs to wear contact lenses in order to work safely.

Contact lenses are not a substitute for protective eyewear. They must be worn with eye protection, preferably cover goggles.

**Head Protection**

Section 22 of the Regulation for Construction Projects (213/91) requires the use of head protection on construction projects. Hard hats are mandatory for all construction workers on the job in Alberta. The hard hat must protect the wearer’s head against impact and against small flying or falling objects, and it must be able to withstand an electrical contact equal to 20,000 volts phase-to-ground.

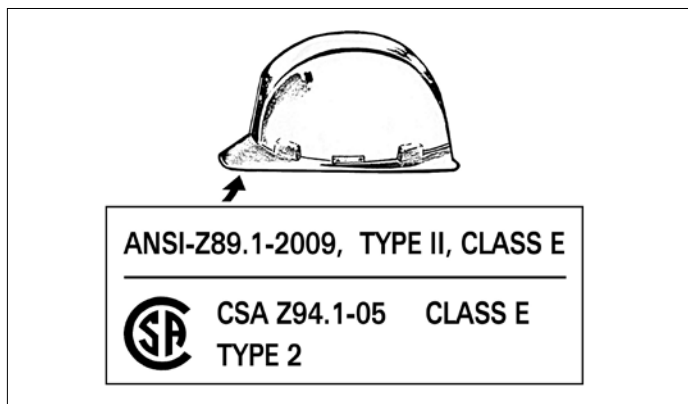

**Figure 8-7: Type 2 Class E Hard Hat**

The following classes of hard hats are considered to be in compliance with the legislation.

## CSA

- Z94.1-05: Class E, Type 1
- Z94.1-05: Class E, Type 2
- Z94.1-1992: Class E

## ANSI

- ANSI Z89.1-2009: Class E, Type I
- ANSI Z89.1-2009: Class E, Type II
- ANSI Z89.1-2003: Class E, Type I
- ANSI Z89.1-2003: Class E, Type II

The Type and Class of hard hat can be found on the CSA or ANSI label. Some manufacturers also stamp the CSA or ANSI classification into the shell of the hat under the brim.

You should normally wear your hard hat facing forward. A hard hat can be worn backwards only if

- it has a reverse orientation mark (Figure 8-8)
- it needs to be worn backwards because of the job, task, or work environment (e.g., wearing a face shield or welding helmet).

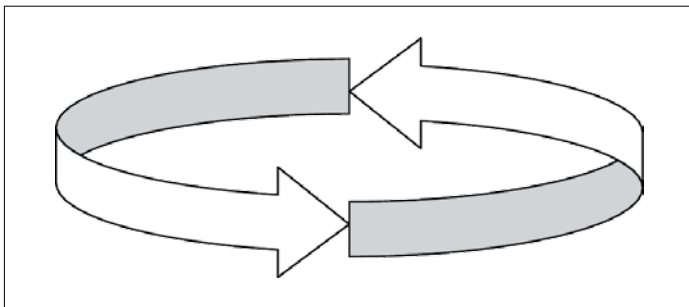

**Figure 8-8: Reverse Orientation Marking**

## Care and Use

- Always consult the manufacturer's instructions for use and care instructions.
- Inspect the shell, suspension, and liner every day before you use it. Look for cracks, dents, cuts, or gouges.
- If a hard hat is struck by an object, do not keep using it.
- Don't store your hard hat in direct sunlight—it will age quicker and become brittle.

- Clean the shell, suspension, and liner regularly with mild soap and water.
- Never alter your hard hat by painting it, making holes in it, etc.
- Don't carry things inside your hard hat.
- Don't wear a baseball cap under your hard hat.
- Check the service life of your hard hat by contacting the manufacturer or reading the manufacturer's instructions.

## Foot Protection

The majority of foot injuries in construction are ankle injuries. To help prevent these injuries, a CSA-certified Grade 1 workboot must be worn (Figure 8-9). This type of boot meets the requirements of the construction regulation (O. Reg. 213/91).

Grade 1 boots can be identified by

- a green triangular patch containing the CSA logo on the outside of the boot
- a green label indicating Grade 1 protection on the inside of the boot.

Grade 1 boots are also available with metatarsal and dielectric protection. A white label with the Greek letter omega in orange means that the boot protects against electric shock under dry conditions.



**Figure 8-9: Grade 1 Safety Boot with CSA Label**

When working with fresh concrete, waterproof rubber boots are essential (Figure 8-10).



**Figure 8-10: Rubber boots**



**Figure 8-11: Waterproof Kneepads**

## Skin Protection

There are a variety of hazards to the skin when working with concrete.

- **Chemical skin burns:** Prolonged contact between wet concrete and the skin can cause severe chemical burns.
- **Skin abrasions:** The sand in concrete can scratch the skin and lead to irritation.
- **Allergic reaction:** Cement usually contains a chemical called hexavalent chromium. When in contact with the skin, this chemical can cause a severe skin allergy.

The following tips can help prevent skin from being exposed to concrete.

- Never allow clothing such as shirts and pants or even protective clothing such as gloves and boots to become saturated with wet concrete.
- Use waterproof gloves.
- Wear a long-sleeved shirt and long pants.
- Wear rubber boots.
- Wash contaminated skin immediately with soap and clean water.
- Use waterproof kneepads (Figure 8-11). They not only protect the knees from injury but also prevent contact with wet concrete.
- Always start the day in clothing that is free from hardened concrete.
- Have a shower at the end of each work day.
- When working with chemicals, consult the safety data sheet (SDS) for the product and take the precautions listed.

## High-Visibility Clothing

Sections 69.1 and 106 of the Regulation for Construction Projects (213/91) require that signallers and workers who may be endangered by vehicular traffic on a project wear a high-visibility garment.

On concrete finishing projects, moving vehicles and equipment such as concrete trucks, concrete pumps, and lift trucks can be hazardous to workers on the site if the drivers or operators don't see them (Figure 8-12).

The high-visibility clothing workers wear must have two distinct features:

- Background Material
- Retroreflective Stripes or Bands.

### Background Material

The garment must be made of fabric that is fluorescent orange or bright orange and makes the wearer more visible in the daytime. Fluorescent orange is recommended because it is easier to see.

### Retroreflective Stripes or Bands

The stripes or bands must be fluorescent and retroreflective. There must be two vertical stripes down the front of the garment and two stripes forming an X on the back. The stripes must be yellow and 50 mm (2 in) wide. Retroreflective stripes make the worker visible both in low light and at night.

For nighttime work, additional stripes or bands are required on the arms and legs. One way to meet that requirement is to dress workers in fluorescent orange coveralls with retroreflective bands or stripes attached.



**Figure 8-12: Wear High-visibility Clothing Around Moving Vehicles and Equipment**

## Respiratory Protection

Respiratory hazards include airborne dusts, gases, fumes, mists, and vapours. When these hazards cannot be eliminated, controlled at their source (i.e., by ventilation), or along the path (i.e., by enclosures), respiratory protection is needed.

Two classes of respirators may be used to protect workers from airborne hazards:

1. Air-purifying respirators
2. Supplied-air respirators.

### Air-Purifying Respirators

Air-purifying respirators work by cleaning the air as it passes through a filter or cartridge connected to the respirator. There are two main types of air-purifying respirators:

- **Non-powered** – Air is drawn through the air-purifying filter, cartridge, or canister when the wearer breathes in. A filtering facepiece is one example (Figure 8-13).
- **Powered** – A fan forces air through the air-purifier and into the facepiece. A powered air-purifying respirator (PAPR) is one example. It provides more comfort when working conditions are hot and humid (Figure 8-13).

Air-purifying respirators have limitations and should not be used in the following situations:

- When workers need to be protected from exposure to carbon monoxide
- When there is not enough oxygen in the air (less than 19.5%),
- When there are very high concentrations of contaminants in the air.

Air-purifying respirators are equipped with a filter, a chemical cartridge, or combination of both. Although there are many kinds of filters for specific hazards, three basic types are used with air-purifying respirators:

1. **Particulate Filter** - This type removes solid particles such as dusts, fumes, or mists. When a particulate filter fills up with dust or fume, it becomes harder to breathe through but more efficient, since air is being filtered through the layer of particles as well. Particulate filters cannot filter out gases or vapours because the molecules are too small.

Particulate filters for non-powered air-purifying respirators are divided into three levels of filter efficiency: 95%, 99%, and 99.97%. The numbers refer to the percentage of particles the filter can remove, based on the particle size most difficult to trap. Oil has been found to ruin the filtering ability of some filter material.

Particulate filters have an **N**, **R**, or **P** rating:

- N** – Not resistant to oil
- R** – Resistant to oil
- P** – oil-Proof.

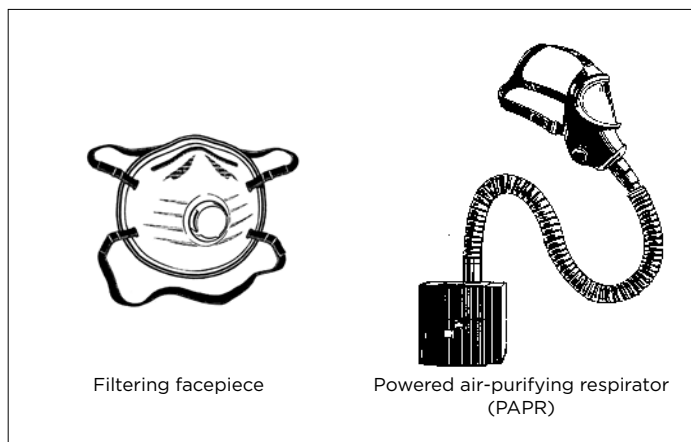

**8-13: Types of Air-Purifying Respirator**

2. **Gas/vapour cartridge** – This type uses substances that absorb or neutralize gases and vapours as they pass through. Unlike particulate filters, gas and vapour cartridge filters become less efficient the longer they are used.

Some cartridges have an end-of-service-life indicator. This indicator changes colour to warn the user to change the cartridge. If the respirator does not have an indicator, a change-

out schedule is needed to calculate when the cartridge needs to be replaced. Consult the respirator manufacturer for guidance on creating this schedule.

- 3. Combination Particulate/Gas/Vapour Cartridge with Filter** – This type removes particulate matter, vapours, and gases from the air. It is used where more than one type of hazard may be present.

### Supplied-Air Respirators

Supplied-air respirators provide clean breathing air from an uncontaminated source, usually a special compressor located in a clean environment, or from cylinders containing compressed breathing air.

There are three basic types of supplied-air respirators:

- 1. Air-line Unit** – relies on a hose that connects the respirator to cylinders of compressed breathing air. An abrasive blasting supplied-air hood is one example (Figure 8-14).
- 2. Ambient Air Blower** – draws air through an inlet hose (positioned where the air is clean) and pumps the air under fairly low pressure to the worker's hood, helmet, or facepiece.
- 3. Self-contained Breathing Apparatus (SCBA)** – uses a cylinder of air carried by the wearer. SCBAs are awkward and heavy, and they require frequent cylinder changes. Combination air-line/SCBA units are available for use in confined spaces and other high-risk work where reserve protection is required (Figure 8-14).

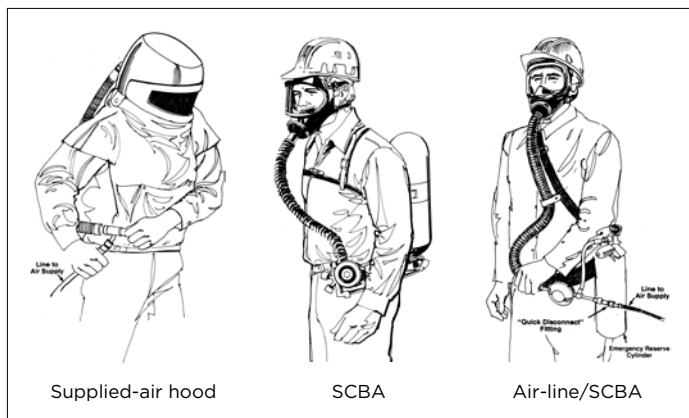

**Figure 8-14: Types of Supplied-Air Respirator**

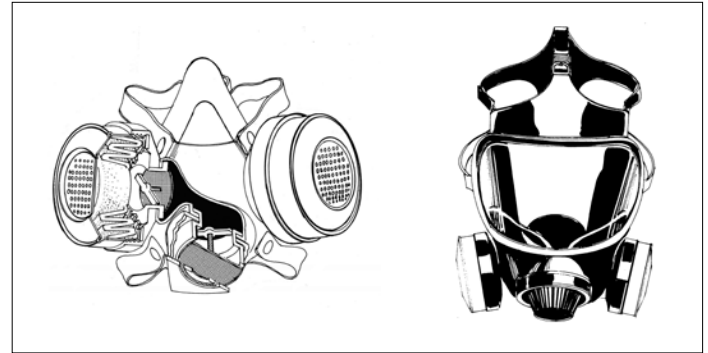

**8-15: Half and Full Facepieces**

### Styles of Facepieces

In addition to the type of respirator, the style of facepiece is used to classify respirators.

**Half Facepiece** is widely used as an air-purifying respirator with one or more filters or cartridges attached to the facepiece. The silicone, thermoplastic, or rubber facepiece covers the mouth and nose, cups under the chin, and is usually held in place by two straps. It generally provides better protection than quarter-face masks because the chin cup affords a more secure fit (Figure 8-15).

**Full Facepiece** covers the entire face and consists of a moulded rubber or plastic frame and a clear visor. Since it fits against the relatively smooth rim of the face, it provides more protection than other face masks. Full-face masks can be used with air-purifying, powered air-purifying, and supplied-air respirators (Figure 8-15).

For help choosing the right kind of respirator for the hazards on site, consult the Respirator Selection Guide (Table 8-1).

### Fit Tests and Seal Checks

Once a respirator has been selected, it is important to make sure that it fits properly. The only way to do that is to have the respirator wearer fit-tested while it's being worn (Figure 8-16).



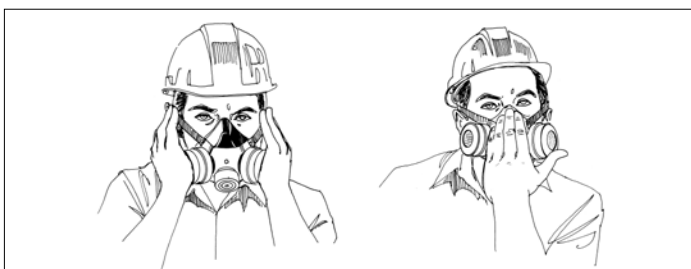

**Figure 8-16: Respirator Fit Test**

Unlike a respirator fit test, a user seal check is made by users of the respirator each time they wear it. This simple procedure confirms whether there are any leaks in the respirator (Figure 8-17).

A user seal check has two steps:

- 1. Negative-Pressure Seal Check** — The wearer puts on the respirator and adjusts it so that it feels fairly comfortable. Then the air inlets are blocked with the hands or a plastic cover, and the wearer inhales gently and holds for five seconds. If the respirator is properly fitted, it should collapse slightly and not permit any air into the facepiece. If leakage is detected, the mask should be readjusted and the test repeated until the fit is satisfactory.
- 2. Positive-Pressure Seal Check** — The wearer puts on the respirator and adjusts it so that it feels fairly comfortable. Then the exhaust port of the respirator is covered and the wearer tries to exhale gently. The facepiece should puff away from the wearer, but there should be no leakage.



**Figure 8-17: Negative-Pressure and Positive-Pressure Seal Checks**



## Respirator Maintenance

Like any equipment, respirators require maintenance. The following instructions cover the major points. Always keep and read the instructions that come with your respirator for full details.

- 1. Change filters and cartridges** as follows:
  - Dust, mist, and fume filters should be changed when there is noticeable resistance to normal breathing.
  - Chemical cartridges should be changed when warning is given by the end-of-service-life indicator or according to the change-out schedule.
  - Any filter should be changed at the frequency specified by the manufacturer or when damaged in any way.
- 2. Check inhalation and exhalation valves** before the respirator is used.
- 3. Replace damaged facepiece, straps, filters, valves, or other parts** with parts from the equipment manufacturer.
- 4. Wash facepieces** with mild soapy water as often as necessary to keep them clean and wearable.
- 5. Assign respirators** to the exclusive use of one worker, if possible.
- 6. Disinfect a respirator after each use** if it has been assigned to more than one worker. Consult the manufacturer about acceptable sanitizers or disinfectants.
- 7. Check all supply hoses, valves, and regulators** on supplied-air respirators as specified by the manufacturer.
- 8. Use and maintain SCBA units and high-pressure cylinders of compressed breathing air** in accordance with current CSA Standards Z180.1-13 Compressed Breathing Air and Systems, and Z94.4-11 Selection, Care and Use of Respirators.
- 9. Maintain compressors and filtration systems** used with supplied-air respirators in accordance with the manufacturer's instructions.
- 10. Consult the manufacturer** for information on replacing respirator cartridges.

IHSA recommends that only NIOSH-approved equipment be used for protection against respiratory hazards.

**Table 8-1: Respirator Selection Guide for Common Construction Activities**

	Air purifying										Supplied air	
	Half facepiece						Full facepiece		Powered air-purifying (PAPR) helmet/hood* or full face	Helmet/hood†	SCBA or SCBA + airline, full facepiece and pressure demand	
	Filtering facepiece		Elastomeric facepiece									
												
Filter efficiency and type	95	100	95	100	Organic vapour	95+ organic vapour	100+ organic vapour	100	100+ organic vapour	100		
Assigned Protection Factor* (CSA Z94.4-11)	10	10	10	10	10	10	10	50	50	1000	1000	10,000

**Painting**

Spraying latex paint	✓ N, R, or P (small-scale)		✓ N, R, or P (small-scale)			✓ N, R, or P (large-scale)						
Alkyds, enamels, and sealers: brush and roller application indoors but well-ventilated					✓ R or P							
Alkyds and enamels: spray painting in well-ventilated area						✓ R or P						
Alkyds and enamels: painting in a confined space												✓
Epoxy or polyurethane spray painting											✓	
Spraying lead paint									✓ N, R, or P	✓		
Spraying stucco						✓ R or P						

**Welding and flame-cutting**

Any welding in confined spaces when the atmosphere is not monitored												✓
Aluminum**	✓ N, R, or P		✓ N, R, or P									
Mild steel	✓ N, R, or P		✓ N, R, or P									
Stainless steel	✓ N, R, or P		✓ N, R, or P									
Galvanized or plated metals	✓ N, R, or P		✓ N, R, or P									
Lead-painted steel: flame cutting or welding, short-term, not repeated, material stripped before work			✓ N, R, or P	✓ N, R, or P								
Welding or high-temperature cutting of lead-containing coatings or materials indoors or in a confined space								✓ N, R, or P		✓	✓	

**N = Not resistant to oil    R = Oil-resistant    P = Oil-proof    OV = Organic vapour cartridge**

✓ Indicates suitable protection. If oil mist is present, use R or P filters.  
 \*\* Protection from ozone may be required in some circumstances. Contact the respirator manufacturer.

\*See page 8-12.  
 †See page 8-12.

**Table 8-1: Respirator Selection Guide for Common Construction Activities**

	Air purifying									Supplied air		
	Half facepiece						Full facepiece			Powered air-purifying (PAPR) helmet/hood* or full face	Helmet/hood†	SCBA or SCBA + airline, full facepiece and pressure demand
	Filtering facepiece		Elastomeric facepiece									
Filter efficiency and type	95	100	95	100	Organic vapour	95+ organic vapour	100+ organic vapour	100	100+ organic vapour	100		
Assigned Protection Factor* (CSA Z94.4-11)	10	10	10	10	10	10	10	50	50	1000	1000	10,000

Synthetic Vitreous Fibres (Man-made mineral fibres)												
Installation, removal, or blowing cellulose, fiberglass, mineral wool, or calcium silicate	✓ N, R, or P	✓ N, R, or P	✓ N, R, or P	✓ N, R, or P								
Installation of refractory ceramic fibres (silica may be present)				✓ N, R, or P								
Removal of refractory ceramic fibres (silica may be present)								✓ N, R, or P		✓		



Other dust and fibre exposure												
Removal of roofing material (built-up roofing, no asbestos)	✓ R or P		✓ R or P									
Dry method dust clean-up from abrasive blasting operations	For short-term applications or applications involving tools or equipment with adequate controls (local exhaust ventilation or water) a half-facepiece respirator may be appropriate.							✓ N, R, or P		✓		
Wood dust, including pressure-treated wood dust	✓ N, R, or P		✓ N, R, or P									
Vinyl or laminate floor sanding	✓ N, R, or P		✓ N, R, or P									

Miscellaneous												
Epoxy adhesive (large-scale use)											✓	
Solvents, adhesives, and epoxy (small scale)					✓ R or P							
Caulking compounds, solvent-based, large-scale use					✓ R or P							
Form oil spraying					✓ R or P							
Paving						✓ R or P						

**N = Not resistant to oil    R = Oil-resistant    P = Oil-proof    OV = Organic vapour cartridge**

✓ Indicates suitable protection. If oil mist is present, use R or P filters.  
 \*See page 8-12.  
 †See page 8-12.

**Table 8-1: Respirator Selection Guide for Common Construction Activities**

	Air purifying								Supplied air			
	Half facepiece				Full facepiece				Powered air-purifying (PAPR) helmet/hood* or full face	Helmet/hood†	SCBA or SCBA + airline, full facepiece and pressure demand	
	Filtering facepiece		Elastomeric facepiece		100		100+ organic vapour					Full-facepiece pressure demand
												
Filter efficiency and type	95	100	95	100	Organic vapour	95+ organic vapour	100+ organic vapour	100	100+ organic vapour	100		
Assigned Protection Factor* (CSA Z94.4-11)	10	10	10	10	10	10	10	50	50	1000	1000	10,000

Silica												
Breaking concrete outdoors	✓ N, R, or P		✓ N, R, or P									
Crushing rock and gravel			✓ N, R, or P	✓ N, R, or P								
Blasting rock			✓ N, R, or P	✓ N, R, or P								
Abrasive blasting—either ≥ 1% silica in the abrasive blasting media or ≥ 1% silica in the target material being blasted											✓	
Drywall sanding			✓ N, R, or P	✓ N, R, or P								
Machine mixing concrete or mortar			✓ N, R, or P	✓ N, R, or P								
Drilling holes in concrete or rock that is not part of a tunnelling operation or road construction			✓ N, R, or P	✓ N, R, or P								
Milling of asphalt from concrete highway pavement			✓ N, R, or P	✓ N, R, or P								
Charging mixers and hoppers with silica sand (sand consisting of at least 95% silica) or silica flour (finely ground sand consisting of at least 95% silica)			✓ N, R, or P	✓ N, R, or P								
Any other operation at a project that requires the handling of silica-containing material in a way that a worker may be exposed to airborne silica			✓ N, R, or P	✓ N, R, or P								
Entry—for less than 15 minutes— into a dry mortar-removal or abrasive-blasting area for inspection or sampling where airborne dust is visible			✓ N, R, or P	✓ N, R, or P								

Continued on next page . . .

**N = Not resistant to oil    R = Oil-resistant    P = Oil-proof    OV = Organic vapour cartridge**

✓ Indicates suitable protection. If oil mist is present, use R or P filters.  
 \*See page 8-12.  
 †See page 8-12.

**Table 8-1: Respirator Selection Guide for Common Construction Activities**

	Air purifying								Supplied air			
	Half facepiece				Full facepiece				Powered air-purifying (PAPR) helmet/hood* or full face	Helmet/hood* NIOSH type CE pressure demand Full-facepiece pressure demand	SCBA or SCBA + airline, full facepiece and pressure demand	
	Filtering facepiece		Elastomeric facepiece		Filtering facepiece		Elastomeric facepiece					
Filter efficiency and type	95	100	95	100	Organic vapour	95+ organic vapour	100+ organic vapour	100	100+ organic vapour	100		
Assigned Protection Factor* (CSA Z94.4-11)	10	10	10	10	10	10	10	50	50	1000	1000	10,000

Silica cont'd												
Entry into an area where abrasive blasting is being carried out for more than 15 minutes									✓ N, R, or P			
Dry method dust clean-up from abrasive blasting operations									✓ N, R, or P	✓		
Removal of silica-containing refractory materials with a jackhammer									✓ N, R, or P	✓		
Drilling holes in concrete or rock as part of a tunnelling operation or road construction									✓ N, R, or P	✓		
Using a power tool to cut, grind, or polish concrete, masonry, terrazzo, or refractory materials									✓ N, R, or P	✓		
Using a power tool to remove silica-containing materials									✓ N, R, or P	✓		
Using a power tool <b>indoors</b> to chip or break and remove concrete, masonry, stone, terrazzo, or refractory materials									✓ N, R, or P	✓		
Tunnelling (operation of tunnel boring machine, tunnel drilling, tunnel mesh insulation)									✓ N, R, or P			
Tuckpointing and surface grinding									✓ N, R, or P			
Dry-mortar removal with an electric or pneumatic cutting device									✓ N, R, or P			
Using compressed air outdoors to remove silica dust									✓ N, R, or P			

For short-term applications or applications involving tools or equipment with adequate controls (local exhaust ventilation or water), a half-facepiece respirator may be appropriate

**N = Not resistant to oil    R = Oil-resistant    P = Oil-proof    OV = Organic vapour cartridge**

✓ Indicates suitable protection. If oil mist is present, use R or P filters.  
 \* Assigned protection factor means the anticipated level of respiratory protection that would be provided by a properly functioning respirator or class of respirators worn by users who are properly fitted and trained. Higher numbers mean greater protection. You may use a respirator with a greater protection factor than the one recommended for your task but never use a respirator with a smaller protection factor.

<sup>†</sup>The employer must have evidence provided by the respirator manufacturer that testing of these respirators demonstrates performance at a level of protection of 1000 or greater to receive an APF of 1000. Without such information, all other PAPRs and SARs with helmets/hoods are to be treated as loose-fitting facepiece respirators, and receive an APF of 25.

NOTE: These recommendations will provide adequate protection in most circumstances. Factors such as ventilation, duration of exposure, and user characteristics can affect how well a respirator protects you. If unsure about the respirator required for a task, contact the manufacturer or IHSA at 1-800-263-5024 or www.ihsa.ca

# CHAPTER 9—FALL PROTECTION



Falls are the number one cause of critical injuries and deaths of Ontario workers on construction sites. Between 1990 and 2008, approximately 162 construction workers in Ontario died from falls.

In 2013, Ontario introduced a new Working at Heights Training Standard to reduce the number of fall fatalities. New legislation requires workers who may use a method of fall protection to complete a working at heights training program that has been approved by Ontario's Chief Prevention Officer. This training must be completed by April 1, 2017, and refresher training must be completed every three years. (See O. Reg. 297/13, s. 6-11.)

## Fall Protection Systems

Fall protection systems are designed to minimize or eliminate the possibility of a worker falling. The preferred method is to install guardrails. The next best option is to use a travel restraint system.

Guardrails and travel restraint prevent a worker from actually falling. When it is not practical to use these methods, a fall protection system such as fall arrest or a safety net can be used. If a worker does fall, a fall protection system can prevent them from hitting the ground or objects below.

Fall prevention also involves putting covers over floor and roof openings and providing the proper access equipment (e.g., ladders, temporary stairs) and work platforms (e.g., scaffolds).

### Travel Restraint

A travel restraint system is a system of fall protection components that allows a worker to travel just far enough to reach the edge but not far enough to fall over (Figure 9-1).

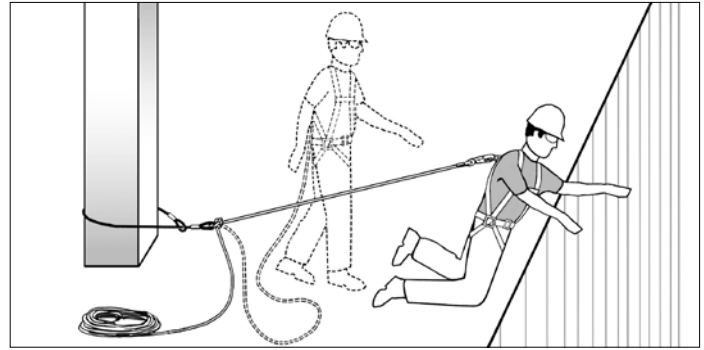

**Figure 9-1: Travel Restraint System**

A fall protection system includes the following CSA-approved equipment:

- Full-body harness
- Lanyard
- Lifeline
- Rope grab to attach harness or lanyard to lifeline.

In addition, a fall protection system must be connected to adequate anchorage (i.e., it must be able to support a static load of 4 kilonewtons or 900 pounds).

### Fall Arrest

A fall arrest system does not prevent a fall but reduces the severity of injury from a fall. It must prevent a falling worker from hitting the ground or any object or level below the work and must not allow them to free-fall more than 1 metre.

A fall arrest system typically consists of a full-body harness connected to an energy-absorbing lanyard that is attached to an anchor, either directly or through a rope grab and lifeline (Figure 9-2).

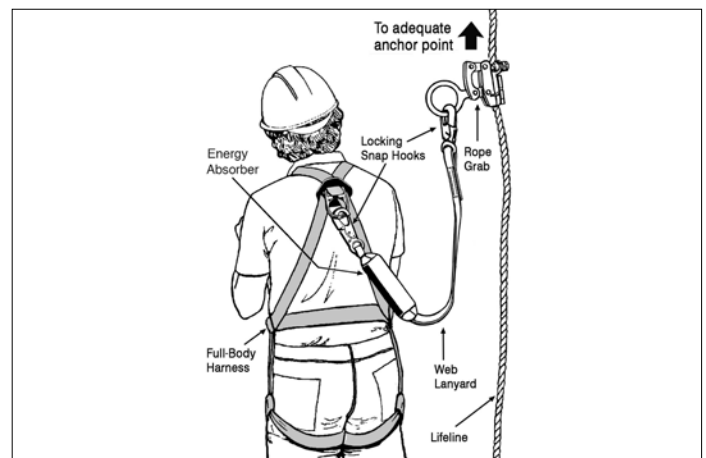

**Figure 9-2: Parts of a Fall Arrest System**

The components of a fall arrest system must be CSA certified and carry a CSA label. Safety harnesses must fit snugly to all parts of the body. All hardware and straps must be intact and properly fastened. The D-ring must be positioned in the centre of the back between the shoulder blades.

Lanyards must be 16 mm (5/8 in) in diameter and made of nylon rope or equivalent. The lanyard should be secured to an anchor point, rope grabbing device, or lifeline with an attachment point preferably higher than waist level. It should be kept as short as possible to reduce fall distance.

Fall arrest equipment must be inspected for damage, wear, and obvious defects by a competent worker before each use. Any worker required to use fall arrest must be trained in its safe use and proper maintenance. For any worker receiving instruction in fall protection, the manufacturers' instructions for each piece of equipment should be carefully reviewed, with particular attention to warnings and limitations.

If workers are required to work in fall arrest, the employer must develop a Fall Arrest Rescue Plan to ensure a fallen worker is rescued as soon as possible without causing injury or putting rescuers at risk. (See Fall Rescue Procedures in Chapter 4.)

## Fall Hazards

Workers must be protected from a fall if they are exposed to any of the following hazards:

- Falling more than 3 m (10 ft)
- Falling more than 1.2 m (4 ft) if the work area is used as a path for a wheelbarrow or similar equipment
- Falling into operating machinery
- Falling into water or another liquid
- Falling into or onto a hazardous substance or object
- Falling through an opening on a work surface. (O. Reg. 213/91, s. 26)

Concrete finishers may encounter such hazards when they are

- Working near unprotected elevated slab edges
- Working near floor openings
- Operating a single or a double float or trowel machine near the edge of an elevated slab
- Working from a ladder
- Using a ramp.

## Guardrails

One of the best and most convenient ways of protecting workers from a fall is to install guardrails. Where possible, guardrails must be installed

- Along the open edges of roofs and floors
- On formwork, scaffolds, and other work surfaces
- Around openings in floors and roofs
- Wherever workers are exposed to the risk of falling.

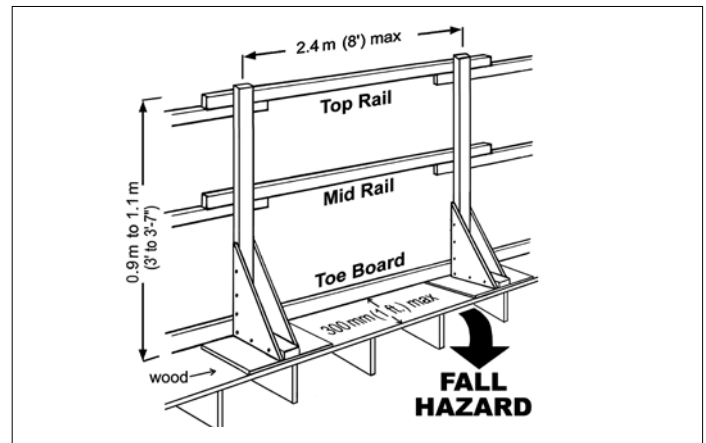

**9-3: Typical Dimensions for Guardrails**

Section 26.3 of the construction regulation requires a guardrail to be used if a worker is exposed to a fall of 2.4 metres or more and has access to the open side of a:

- Floor, including a mezzanine or balcony floor
- Bridge surface
- Roof while formwork is in place
- Scaffold platform or other work platform, runway or ramp.

The specifications for a guardrail systems are found in section 26.3 (4) of the Construction Projects regulation (See Figure 9-3). They include:

- A top rail, mid rail, and toeboard secured to vertical supports
- A top rail between 0.9 m (3 feet) and 1.1 m (3 feet 7 inches) high
- A toeboard at least 100 mm (4 inches) high—89 mm (3 1/2 inches) high if made of wood—and installed flush with the surface
- Posts no more than 2.4 metres (8 feet) apart
- Be installed no further than 300mm (1 foot) from an edge.

Section 26.3 of the regulation also specifies the following:

- Load bearing capabilities of guardrail systems (See 26.3 (5))
- Requirements for wooden guardrails (See 26.3 (7) and (7.1))
- Requirements for wire rope guardrails (See 26.3 (8))

### Safe Work Practices

- If a section of guardrail is removed to receive materials, never leave it unattended.
- Always assume that a guardrail may not be strong enough to support a load that it is put on it.
- Guardrails are required around all slab edges and slab openings. Ensure they are secure before the starting work.
- Beware of unsupported or unsecure metal decks.
- Use extreme caution near guardrails—never lean on or exert sideways pressure on guardrails.
- Express concerns over any deficiencies in the guardrail or opening covers immediately—do not leave dangerous conditions unattended (protect other workers).
- Do not work continuously near guardrails without consideration for additional fall protection.
- Never work with the slab edge or opening immediately behind you (face the slab edge).
- Be aware that kickback from a trowel machine can push a worker towards a guardrail.

If it is not reasonably possible to install a guardrail system OR if guardrails are removed temporarily, the construction regulation requires that a worker be protected by one of the following means of fall protection:

- A travel restraint system that meets the requirements of section 26.4
- A fall restricting system that meets the requirements of section 26.5
- A fall arrest system, other than a fall restricting system designed for use in wood pole climbing, that meets the requirements of section 26.6
- A safety net that meets the requirements of section 26.8

## Floor Openings

Guardrails are the preferred method for protecting workers near floor openings. However, they may not always be practical, such as in narrow access routes. In such cases, the best alternative may be securely fastened covers made of planks, plywood, or steel plates (Figure 9-4).

According to section 26.3 (2) of the construction regulation, a protective cover must:

- Cover the opening completely
- Be securely fastened
- Be labelled as a covering for an opening
- Be made of material that can support all loads that may be placed on it
- Be able to support a live load of at least 2.4 kilonewtons per square metre without exceeding the allowable unit stresses for the material used.

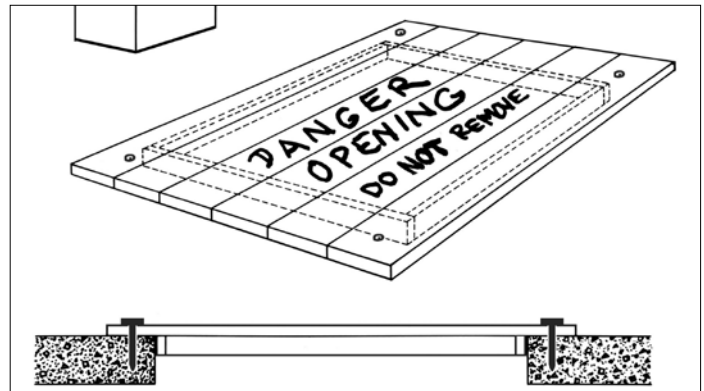

Figure 9-4: Pallet-Style Cover

### Safe Work Practices

- Never stand or walk on a protective cover.
- Never store materials on a protective cover.
- Never drive over a protective cover.
- Always fasten the cover securely to prevent workers from removing it and falling through.
- Where permanent covers or hatches are installed, they should be kept closed at all times except when they are being used for access.
- Tell your supervisor if a protective cover is loose, not fastened, not properly identified, or in poor condition.
- If an opening is not covered, always use another means of fall protection when working around it.



## Temporary Stairs

On residential construction sites, temporary stairs are often put in place before the permanent stairs are built. If temporary stairs are not installed properly, are poorly designed, or are not maintained, a worker can fall off or the stairs can collapse. This can cause serious injury or even death.

### Temporary Stair Hazards

The stairway is not properly secured at the header and the base. This may cause the stairs to slip and slide when heavy weights are placed on the stairs (Figure 9-5).

- The stairs are not in good condition. Cracked or missing stringers, steps, and grooves may reduce the strength of the structure and cause a collapse when heavy weights are applied.
- The bottom of the stairway is installed over a floor opening that may not be able support the weight of heavy loads (Figure 9-6).
- The stairway is too long or short to attach to the floor at a correct angle (Figure 9-7).
- The stairway going down to the basement is installed without making allowances for pouring the concrete slab. If workers have to raise or move the stairs, it reduces the structural integrity of the stairs and all connecting points.
- The stairway is installed at an improper location (Figure 9-8).
- A ramp used as a stairway does not comply with O. Reg. 213/91, s. 73 and 74. (Figure 9-9).
- A buildup of ice and snow on the stairs cause a slip and fall hazard (Figure 9-10).
- The stairs are too narrow (Figure 9-11).



**Figure 9-5: Bottom of stairway is not attached properly to the floor**



**Figure 9-6: Stairway is too short and installed above a floor opening**



**Figure 9-7: Slope of the stairway is steeper than the maximum allowed**



**Figure 9-8: Stairway is poorly located**



**Figure 9-11: Stairway is too narrow and has steps missing**



**Figure 9-9 Ramp is not strong enough or not at the proper slope to be used as a stairway.**



**Figure 9-10: A fall hazard is caused by excessive ice and snow.**

### Safe Work Practices

- Follow the requirements for temporary stairs in the construction regulation (O. Reg. 213/91, s. 73 to 77).
- When you go onto the site, make sure the temporary stairs are safe to use. Inspect the stairs, headers, footers, and handrails to make sure they're in good condition.
- Check the temporary stairs to make sure they meet the requirements in section 77 of the construction regulation. Use Figure 9-12 as a reference guide.
- Do not tamper with the stairway or make any changes to it.
- If you are unsure of the condition of the temporary stairs or if you see a warning sticker on the permanent stairs, do not use it. Check with your supervisor or employer, or use another way of reaching a higher or lower work area.
- Consult the site supervisor before using stairs with warning signs (Figure 9-13).

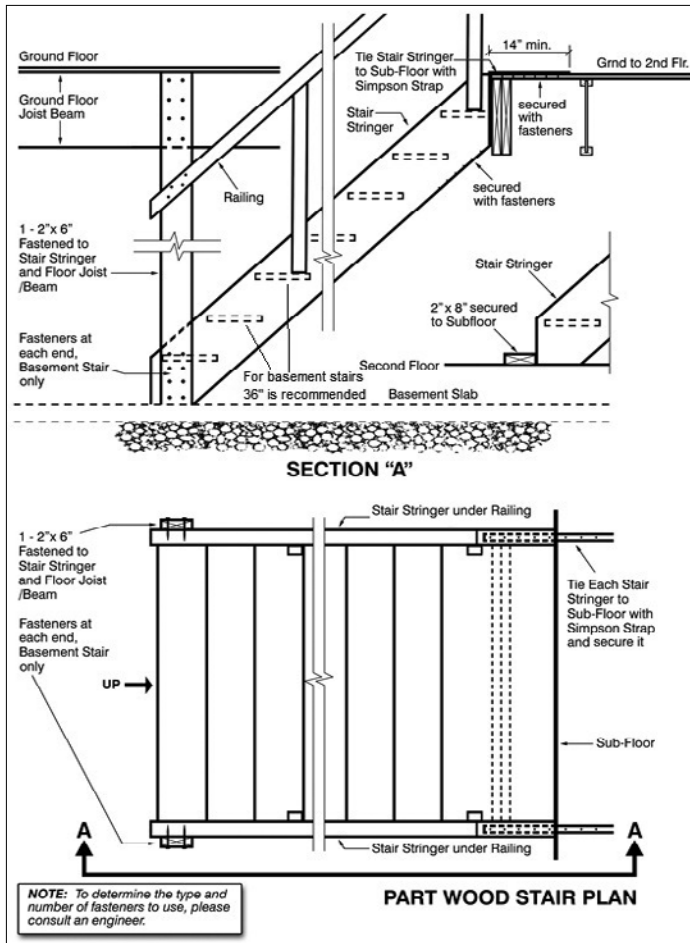

Source: Ontario Concrete & Drain Contractors Association

**Figure 9-12: Temporary Basement Wood Stair Installation Detail**

NOTE: The guardrails or walls on the upper floor/landing have been excluded to keep the diagram clear.



**Figure 9-13: Warning sign on temporary stairs**

# APPENDIX A—STRETCHING EXERCISES

## Explain dangers

Getting ready for the job means more than lining up tools and material. We should get our muscles ready too. Exercising before work can help prevent back, neck, and shoulder injuries.

## Demonstrate

We recommend you hand out IHSA's *Before You Start Work* exercises card (V012) to your employees. Learn to do the exercises before you give the talk. Demonstrate each exercise to the group, and ask the group to do it after you.

**CAUTION:** Participation must be voluntary. If workers have any doubts about their ability to do the exercises safely, they should not do them. If they feel any pain, they should stop immediately.

## Warm up first

This helps to get your muscles warm and loose. A warm muscle is a lot less likely to tear than a cold one.

## March in Place

Stand in position. Pump your arms and legs in opposite directions. Make sure that your heels touch the ground. Continue 3 to 5 minutes.



## Arm Circles

Stand with arms raised horizontally and slightly in front of shoulders, palms down, and feet shoulder-width apart. Rotate arms in a forward circular motion for 15 seconds. Relax. Repeat 3 to 5 times.

Now we're ready for some stretching exercises. They should be performed in a slow, controlled manner and held in a sustained stretch for 20 to 30 seconds. Avoid bouncy, jerky movements. Stretch only to a comfortable position, not to the point of pain.

## Knee to Chest

Support yourself with one hand. With your free hand, pull your knee toward your chest and hold it for 30 seconds. Repeat with the other leg. Repeat 3 times for each leg.



## Hip Stretch

Stand with one foot in front of the other. Place your hands just above the knee of your front leg. Gently bend your front knee. Keep your back foot flat on the floor. Hold 20 to 30 seconds. Repeat with other leg. Repeat 3 times for each leg.

## Thigh Stretch

Support yourself with one hand. With your free hand, bend your leg back and grasp your ankle. Gently pull your ankle towards your body. Keep your trunk straight. Hold 20 to 30 seconds. Then repeat with the other leg. Repeat 3 times for each leg.



## Calf Stretch

Lean on a solid support with your outstretched hands. Bend one leg forward and extend the other leg straight behind you. Slowly move your hips forward. Keep the heel of your back leg on the ground. Hold 30 seconds, relax, and repeat with the other leg. Repeat 3 times for each leg.



## Backward Stretch

Stand up and bend backwards, holding for 2 to 4 seconds. Repeat 3 times. This will help relieve lower-back muscle tension. Do this stretch after working in a crouched, bent, or stooped position.



# APPENDIX B—HAND SIGNALS

## Hand Signals for On-Site Traffic Control

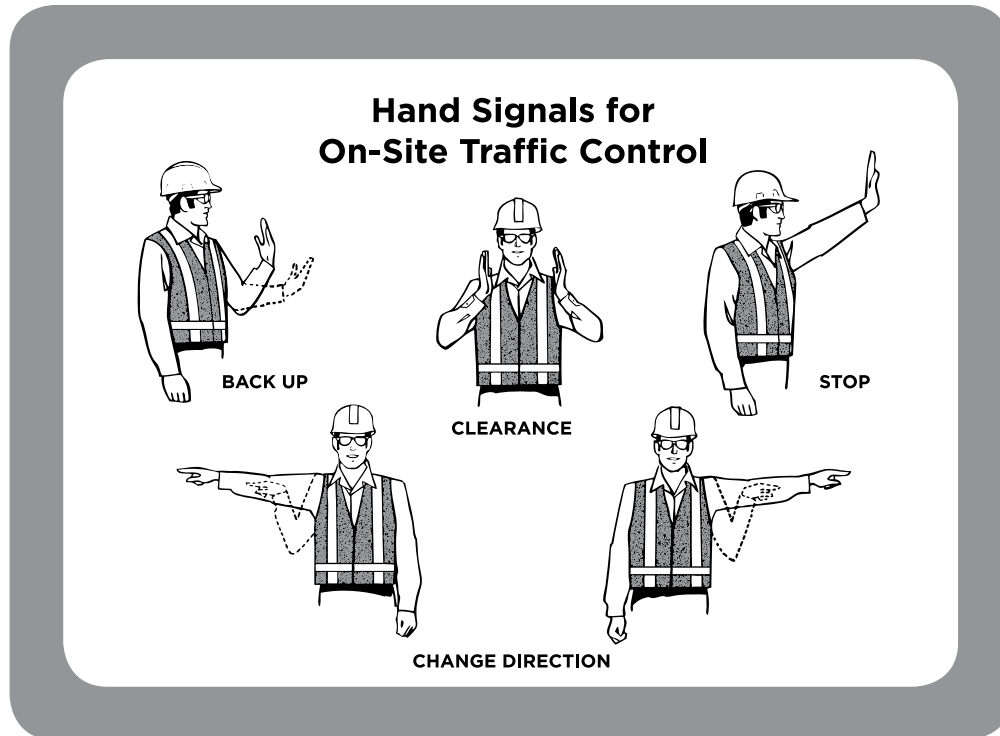

















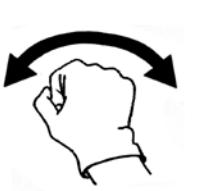

### Signal personnel should

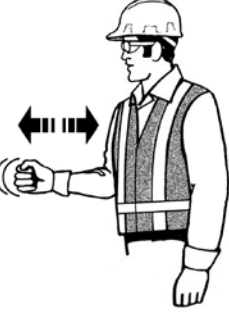
- stand in full view of the operator
- communicate with the operator by the signals shown on this card
- have a full view of the intended path of travel
- keep clear of the intended path of travel.

V006

To order pocket-sized versions of this card, go to [ihsa.ca/products](http://ihsa.ca/products) and search for *Hand Signals for On-Site Traffic Control (V006)*.

## Hand Signals for Ready-Mix Drivers & Concrete Pumping

 <b>Head In</b>	 <b>Back In</b>	 <b>Back Up</b>	 <b>Pull Forward</b>	 <b>Stop</b>
 <b>Raise Chute</b>	 <b>Lower Chute</b>	 <b>Start pouring</b>	 <b>Stop Pouring</b>	 <b>Lock or Unlock Chute</b>
 <b>Slow Down Drum</b>	 <b>Start Pump Speed Up</b>	 <b>Slow Pump Down</b>	 <b>Stop Pump</b>	 <b>Little Bit</b>
 <b>2 Taps</b>	 <b>All Done Clean Up</b>	 <b>Boom Left</b>	 <b>Boom Right</b>	 <b>Stop Boom</b>

**NO RESPONSE SHOULD BE MADE TO UNCLEAR SIGNALS**

To order pocket-sized versions of this card, go to [ihsa.ca/products](http://ihsa.ca/products) and search for *Hand Signals for Ready-Mix Drivers & Concrete Pumping (V007)*.